

Sound Bar

Operating Instructions

Owner's Record

The model and serial numbers are located on the bottom of the bar speaker. Record the serial numbers in the space provided below. Refer to them whenever you call upon your Sony dealer regarding the speaker system.

Model No. HT-S400
 Serial No. _____



5-034-773-11 (1)

HT-S400

WARNING

The speaker system is not disconnected from the mains as long as it is connected to the AC outlet, even if the speaker system itself has been turned off.

To reduce the risk of fire, do not cover the ventilation opening of the speaker system with newspapers, tablecloths, curtains, etc. Do not expose the speaker system to naked flame sources (for example, lighted candles).

To reduce the risk of fire or electric shock, do not expose this speaker system to dripping or splashing, and do not place objects filled with liquids, such as vases, on the speaker system.

As the mains plug is used to disconnect the speaker system from the mains, connect the speaker system to an easily accessible AC outlet. Should you notice an abnormality in the speaker system, disconnect the mains plug from the AC outlet immediately.

Do not install the speaker system in a confined space, such as a bookcase or built-in cabinet.

CAUTION
 Risk of explosion if the battery is replaced by an incorrect type.
 Do not expose batteries or appliances with battery-installed to excessive heat, such as sunshine and fire.

Do not place this product close to medical devices.
 This product (including accessories) has magnet(s) which may interfere with pacemakers, programmable shunt valves for hydrocephalus treatment, or other medical devices. Do not place this product close to persons who use such medical devices. Consult your doctor before using this product if you use any such medical device.

Indoor use only.

For the bar speaker

The nameplate is located on the bottom of the bar speaker.

For customers in the U.S.A.

NOTE
 This speaker system has been tested and found to comply with the limits for a Class B digital device, pursuant to Part 15 of the FCC Rules. These limits are designed to provide reasonable protection against harmful interference in a residential installation. This speaker system generates, uses and can radiate radio frequency energy and, if not installed and used in accordance with the instructions, may cause harmful interference to radio communications. However, there is no guarantee that interference will not occur in a particular installation. If this speaker system does cause harmful interference to radio or television reception, which can be determined by turning the speaker system off and on, the user is encouraged to try to correct the interference by one or more of the following measures:
 – Reorient or relocate the receiving antenna.
 – Increase the separation between the speaker system and receiver.
 – Connect the speaker system into an outlet on a circuit different from that to which the receiver is connected.
 – Consult the dealer or an experienced radio/TV technician for help.

Properly shielded and grounded cables and connectors must be used for connection to host computers and/or peripherals in order to meet FCC emission limits.

If you have any questions about this speaker system:
 Visit: <https://www.sony.com/electronics/support>
 Contact: Sony Customer Information Service Center at 1-800-222-SONY (7669)
 Write: Sony Customer Information Service Center 12451 Gateway Blvd., Fort Myers, FL 33913

Supplier's Declaration of Conformity
 Trade Name: SONY
 Model No.: HT-S400
 Responsible Party: Sony Electronics Inc.
 Address: 16535 Via Esprillo, San Diego, CA 92127 USA
 Telephone No.: 858-942-2230

This device complies with Part 15 of the FCC Rules. Operation is subject to the following two conditions: (1) This device may not cause harmful interference, and (2) this device must accept any interference received, including interference that may cause undesired operation.

CAUTION

You are cautioned that any changes or modifications not expressly approved in this manual could void your authority to operate this speaker system.

This speaker system must not be co-located or operated in conjunction with any other antenna or transmitter.

This speaker system complies with FCC radiation exposure limits set forth for an uncontrolled environment and meets the FCC radio frequency (RF) Exposure Guidelines. This speaker system should be installed and operated keeping the radiator at least 20 cm or more away from person's body.

For customers in Canada

Properly shielded and grounded cables and connectors must be used for connection to host computers and/or peripherals.

This speaker system contains license-exempt transmitter(s)/receiver(s) that comply with Innovation, Science and Economic Development Canada's license-exempt RSS(s). Operation is subject to the following two conditions:

- This speaker system may not cause interference; and
- This speaker system must accept any interference, including interference that may cause undesired operation of the speaker system.

This speaker system complies with ISED radiation exposure limits set forth for an uncontrolled environment and meets RSS-102 of the ISED radio frequency (RF) Exposure rules. This speaker system should be installed and operated keeping the radiator at least 20 cm or more away from person's body.

Precautions

On safety

- Should any solid object or liquid fall into the speaker system, unplug the speaker system and have it checked by qualified personnel before operating it any further.
- Do not climb on the speaker system, as you may fall down and injure yourself, or speaker system damage may result.

On power sources

- Before operating the speaker system, check that the operating voltage is identical to your local power supply. The operating voltage is indicated on the nameplate on the bottom of the bar speaker.
- If you are not going to use the speaker system for a long time, be sure to disconnect the speaker system from the wall outlet (mains). To disconnect the AC power cord (mains lead), grasp the plug itself, never pull the cord.
- One blade of the plug is wider than the other for the purpose of safety and will fit into the wall outlet (mains) only one way. If you are unable to insert the plug fully into the outlet, contact your dealer.
- The AC power cord (mains lead) must be changed only at a qualified service shop.

On heat buildup

Although the speaker system heats up during operation, this is not a malfunction. If you continuously use this speaker system at high volume, the speaker system temperature at the rear and bottom rises considerably. To avoid burning yourself, do not touch the speaker system.

On placement

- Place the speaker system in a location with adequate ventilation to prevent heat buildup and prolong the life of the speaker system.
- Do not place the speaker system near heat sources or in a place subject to direct sunlight, excessive dust, or mechanical shock.
- Do not place anything on the top of the bar speaker.
- If the speaker system is being used in combination with a TV, VCR, or tape deck, noise may result and picture quality may suffer. In such a case, place the speaker system away from the TV, VCR, or tape deck.
- Use caution when placing the speaker system on a surface that has been specially treated (with wax, oil, polish, etc.), as staining or discoloration of the surface may result.
- Take care to avoid any possible injury from the corners of the bar speaker.

On operation

Before connecting other equipment, be sure to turn off and unplug the speaker system.

If you encounter color irregularity on a nearby TV screen

- Color irregularities may be observed on certain types of TV.
- If color irregularity is observed... Turn off the TV, then turn it on again after 15 to 30 minutes.
 - If color irregularity is observed again... Place the speaker system further away from the TV.

On cleaning

- Clean the speaker system with a soft, dry cloth. Do not use any type of abrasive pad, scouring powder, or solvent such as alcohol or benzene.

If you have any questions or problems concerning your speaker system, please consult your nearest Sony dealer.

About These Operating Instructions

- The instructions in these Operating Instructions describe the controls on the remote control.
- Some illustrations are presented as conceptual drawings, and may be different from the actual products.
- Characters in brackets [] appear in the front panel display.

Installation and Connection

Connecting a TV with an HDMI Cable and/or Optical Cable

Refer to Startup Guide (separate document).

Mounting the Bar Speaker on a Wall

You can mount the bar speaker on a wall.

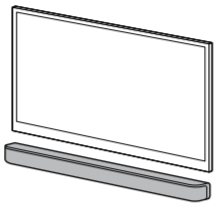

Notes

- Prepare screws (not supplied) that are suitable for the wall material and strength. As a plasterboard wall is especially fragile, attach the screws securely in the wall beam. Install the bar speaker horizontally, hung by screws in studs in a continuous flat section of the wall.
- Have the installation done by a Sony dealer or licensed contractor and pay special attention to safety during the installation.
- If using a cable with a large plug, it may not be possible to mount the bar speaker on a wall.
- Sony shall not be held responsible for accidents or damage caused by improper installation, insufficient wall strength, improper screw installation, natural disasters, etc.

- Prepare two screws (not supplied) that are suitable for the wall mount holes on the rear of the bar speaker.

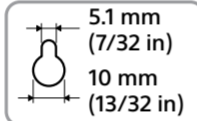
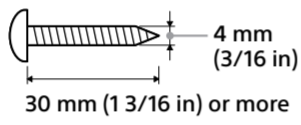

Hole on the rear of the bar speaker

- Align the vertical line above the "▲ TV CENTER LINE" printed on the WALL MOUNT TEMPLATE (supplied) with the center of the width of your TV.

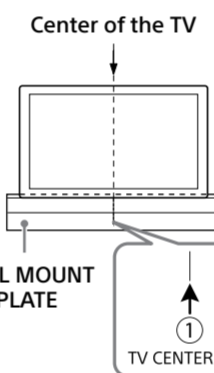

- Align the "◀ TV BOTTOM LINE" printed on the WALL MOUNT TEMPLATE with the bottom of your TV, then adhere the WALL MOUNT TEMPLATE on the wall with a commercially available adhesive tape, etc.

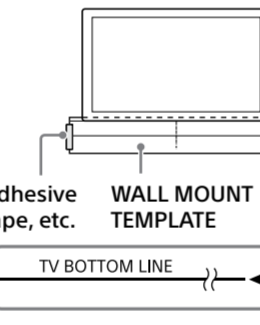

- Fasten the screws prepared in step 1 securely into the screw marks (Ⓢ) on the "◀ TV SCREW LINE" printed on the WALL MOUNT TEMPLATE.

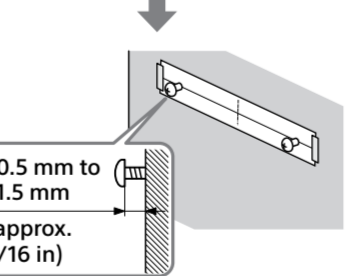
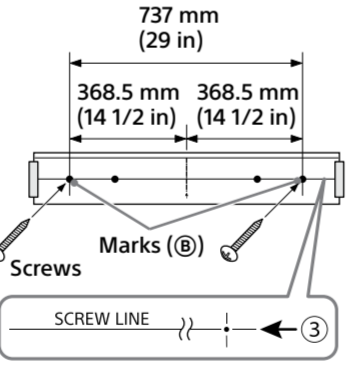

- Remove the WALL MOUNT TEMPLATE.

- Hang the bar speaker on the screws. Align the holes on the rear of the bar speaker with the screws, then hang the bar speaker on the two screws.

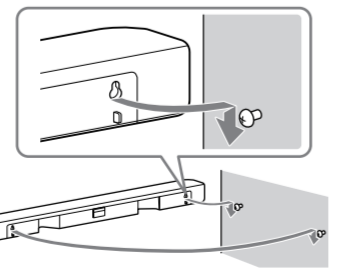

Note

When sticking WALL MOUNT TEMPLATE, smooth it out fully.

Connecting the Subwoofer Manually

If you cannot connect the subwoofer to the speaker system, or you use multiple wireless products and want to specify the wireless connection to link the speaker system to the subwoofer, perform the manual connection.

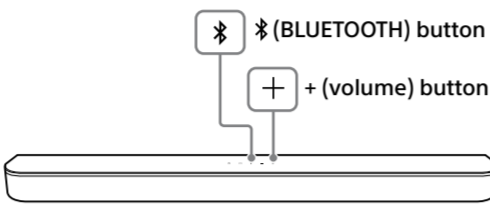
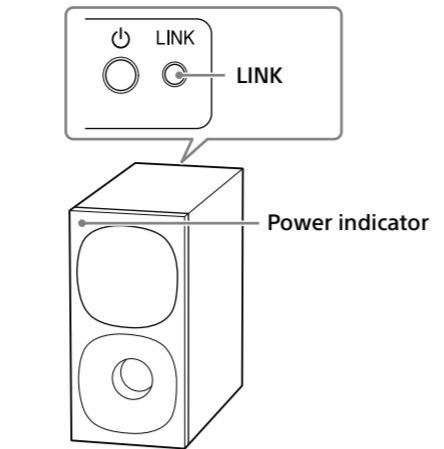

- Press and hold [BLUETOOTH] and + (volume) on the bar speaker for more than 5 seconds. [SECURE LINK] appears, then [LINK] flashes in the front panel display. To cancel the manual connection, press and hold [BLUETOOTH] and + (volume) on the bar speaker for more than 5 seconds again.
- Press LINK on the subwoofer. The manual connection starts. The power indicator of the subwoofer flashes in amber.
- Make sure that [DONE] appears in the front panel display. The manual connection is established and the power indicator of the subwoofer lights in amber.

Note
 If [ERROR] appears in the front panel display, the connection of the subwoofer has not been established. Perform the manual connection again.

Parts and Controls

Bar Speaker

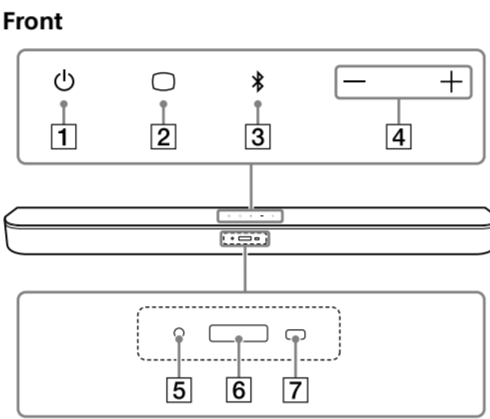

- (power) button Turns on the speaker system or sets it to standby mode.
- [TV] button Turns on/off the surround effect.
- [BLUETOOTH] button Turns on the speaker system or sets it to standby status
- +/- (volume) buttons Adjusts the volume.
- BLUETOOTH indicator Flashes twice in blue: During pairing standby status
- Flashes in blue: BLUETOOTH connection is being attempted.
- Lights in blue: BLUETOOTH connection has been established.
- Front panel display
- Remote control sensor Point the remote control at the remote control sensor to operate the speaker system.

Rear

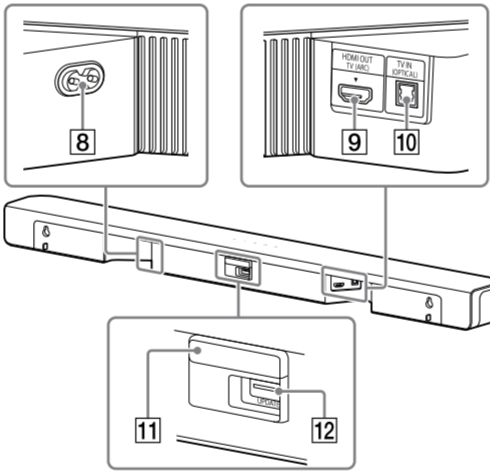

- AC inlet
- HDMI OUT (TV (ARC)) jack Connect a TV that has an HDMI input jack with an HDMI cable. The speaker system is compatible with Audio Return Channel (ARC). ARC is the function that sends TV sound to an AV device such as the speaker system from the TV's HDMI jack.
- TV IN (OPTICAL) jack
- IR repeater Transmits the remote signal of the TV remote control to the TV.
- UPDATE port Connect the USB memory when updating the speaker system.

Subwoofer

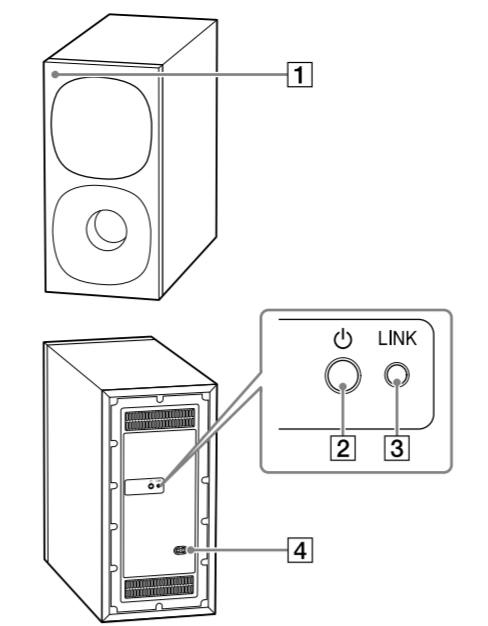

- Power indicator
 - Lights in green: The subwoofer is connected to the speaker system.
 - Lights in red: The subwoofer is in standby mode.
 - Lights in amber: The subwoofer is connected to the speaker system with the manual connection.
 - Flashes slowly in green: The subwoofer is attempting to connect to the speaker system.
 - Flashes slowly in amber: The subwoofer is attempting to connect to the speaker system with the manual connection.
 - Flashes twice in amber: The subwoofer is in pairing standby status with the manual connection.
 - Flashes quickly in amber: The software is updating.
 - Turns off: The subwoofer is turned off.
- (power) button Turns on or off the subwoofer.
- LINK button
- AC inlet

Remote Control

Some buttons function differently depending on how long the button is pressed. This section explains the functions when pressed shortly. For details about other functions, refer to "Changing the Settings" on the back page.

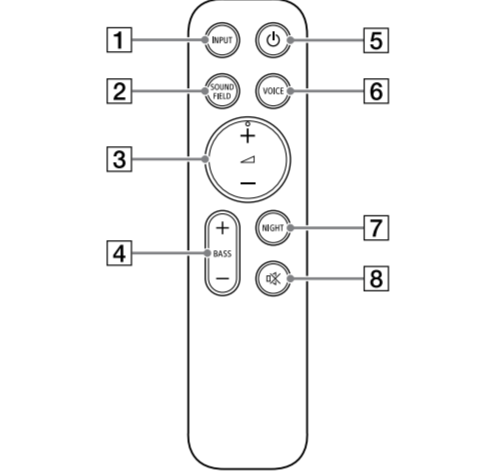

- INPUT Selects the input for playback on the speaker system. Each time you press INPUT, the input source toggles between the TV and BLUETOOTH input.
- SOUND FIELD Turns on/off the surround effect.
- (volume) +/- Adjusts the volume.
- BASS +/- Adjusts the subwoofer volume.
- (power) button Turns on the speaker system or sets it to standby mode.
- VOICE Turns on/off the voice mode.
- NIGHT Turns on/off the night mode.
- (muting) button Mutes the sound temporarily.

* The (volume) +/- button has a tactile dot. Use it as a guide during operation.
About the replacement of batteries for the remote control
 When the speaker system does not respond by operating with the remote control, replace two batteries with new batteries. Use R03 (size AAA) manganese batteries for replacement.

Listening to Music/Sound

Listening to a TV Connected with an HDMI Cable (ARC) or Optical Digital Cable

You can listen to TV sound on the speaker system.

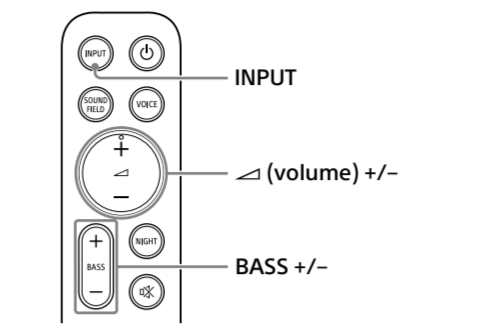
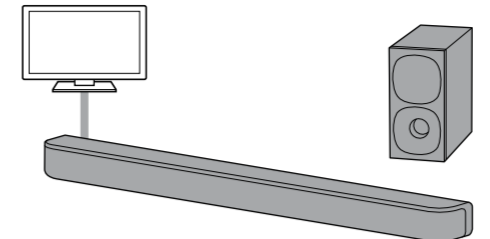

- Press INPUT repeatedly to select [TV] in the front panel display.
- Adjust the volume.
 - Adjust the volume by pressing (volume) +/- on the remote control.
 - Adjust the subwoofer volume by pressing BASS +/- on the remote control.

Note
 When you connect the TV to both the HDMI OUT (TV (ARC)) and TV IN (OPTICAL) jacks, the jack for audio input is selected depending on which audio signal is input first.

Tip
 You can also select the input by pressing [TV] on the bar speaker.

Listening to Music from a Mobile Device with the BLUETOOTH® Function

You can listen to music stored on a mobile device such as a smartphone or tablet via wireless connection by connecting the speaker system and the mobile device with the BLUETOOTH function. When connecting to the mobile device with the BLUETOOTH function, you can perform operations simply through the speaker system without turning the TV on.

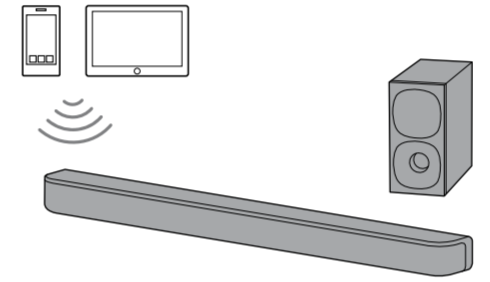

Listening to Music by Pairing with a Mobile Device

You need to perform pairing of the speaker system and mobile device by using the BLUETOOTH function. Pairing is the process required to mutually register the information on BLUETOOTH devices to be connected wirelessly in advance.

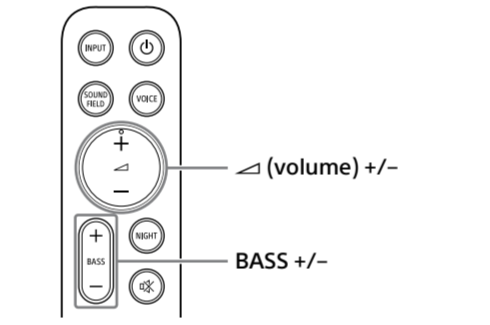

- Press and hold [BLUETOOTH] on the bar speaker for 2 seconds.

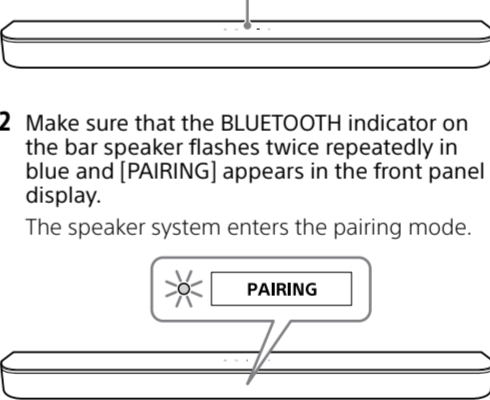

- On the mobile device, search for the speaker system by performing the pairing operation. The list of the BLUETOOTH devices that are detected appears on the screen of the mobile device. For the operation method to pair the BLUETOOTH device to the mobile device, refer to the operating instructions of the mobile device.
- Pair the speaker system and mobile device by selecting "HT-S400" from the list on the screen of the mobile device. If a passkey is requested, enter "0000."

- Make sure that the BLUETOOTH indicator on the bar speaker lights in blue and [BT] appears in the front panel display. A connection between the speaker system and mobile device has been established.
- Start audio playback with the music app on the connected mobile device. Sound is output from the speaker system.
- Adjust the volume.
 - Adjust the volume by pressing (volume) +/- on the remote control.
 - Adjust the subwoofer volume by pressing BASS +/- on the remote control.

Notes
 • You can pair up to 9 BLUETOOTH devices. If a 10th BLUETOOTH device is paired, the oldest connected device will be replaced by the new one.
 • Perform pairing for the second and subsequent mobile devices.

Tips
 • You can check the connection status of the BLUETOOTH function by checking the BLUETOOTH indicator status.
 • While the BLUETOOTH input is being selected, the speaker system enters the pairing mode by pressing [BLUETOOTH] on the bar speaker shortly.

Listening to Music from the Paired Mobile Device

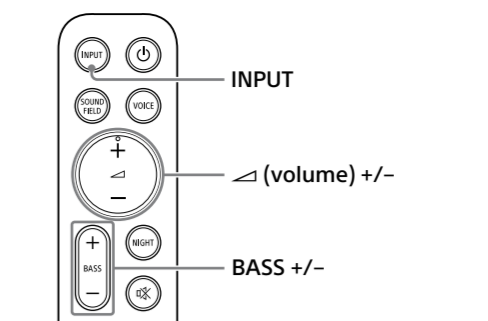

- Turn the BLUETOOTH function of the mobile device on.
- Press INPUT repeatedly to select [BT] or press [BLUETOOTH] on the bar speaker shortly. The BLUETOOTH indicator flashes and the speaker system automatically reconnects to the BLUETOOTH device it was most recently connected to.
- Make sure that the BLUETOOTH indicator on the bar speaker lights in blue and [BT] appears in the front panel display. A connection between the speaker system and mobile device has been established.
- Start audio playback with the music app on the connected mobile device. Sound is output from the speaker system.
- Adjust the volume.
 - Adjust the volume by pressing (volume) +/- on the remote control.
 - Adjust the subwoofer volume by pressing BASS +/- on the remote control.

Listening to Sony TV Sound with the BLUETOOTH Function

What You Can Do by Connecting a TV with the BLUETOOTH Function
 When using Sony TV* with the BLUETOOTH function, you can listen to sound of the TV or device that is connected to the TV by connecting the speaker system and TV wirelessly.

* The TV needs to be compatible with A2DP (Advanced Audio Distribution Profile) of the BLUETOOTH profile.

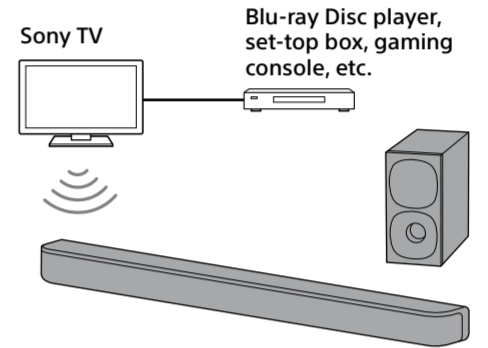

Listening to TV Sound by Connecting the Speaker System and TV Wirelessly

You need to perform pairing of the speaker system and TV by using the BLUETOOTH function.

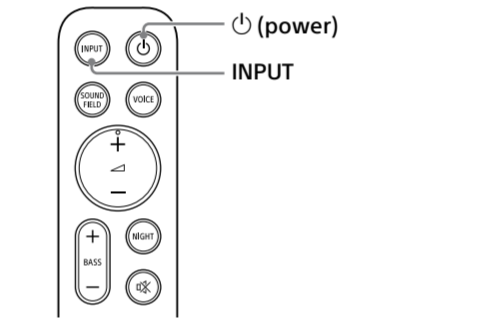

- Turn on the TV.
- Press (power) to turn on the speaker system.
- Press and hold [BLUETOOTH] on the bar speaker and INPUT on the remote control simultaneously for 5 seconds. The speaker system enters the BLUETOOTH pairing mode. [TV-BT] and [ON] appears in blue in the front panel display.

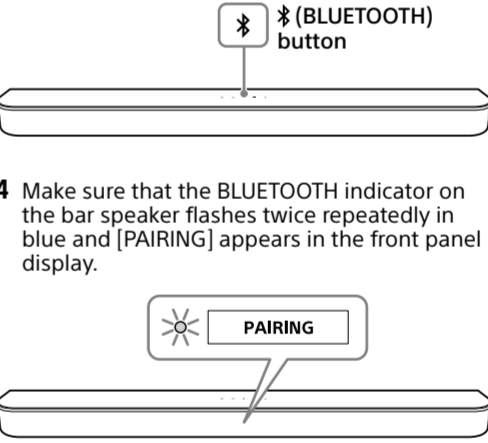

- On the TV, search for the speaker system by performing the pairing operation. The list of the BLUETOOTH devices that are detected appears on the TV screen. For the operation method to pair the BLUETOOTH device to the TV, refer to the operating instructions of the TV.
- Pair the speaker system and TV by selecting "HT-S400" from the list on the TV screen.

- Make sure that the BLUETOOTH indicator on the bar speaker lights in blue and [TV-BT] appears in the front panel display. A connection between the speaker system and TV has been established.
- Select the program or input of the device by using the TV remote control. The sound of the displayed image on the TV screen is output from the speaker system.
- Adjust the volume of the speaker system by using the TV remote control. When pressing the muting button on the TV remote control, the sound is muted temporarily.

Notes
 • If the TV sound is not output from the speaker system, press INPUT to select the TV input and check the status of the front panel display and indicators on the bar speaker.

- [TV-BT] appears in the front panel display. The speaker system and TV are connected, and TV sound is output from the speaker system.
- The BLUETOOTH indicator flashes twice repeatedly and [PAIRING] appears in the front panel display. Perform pairing on the TV.
- [TV] appears in the front panel display. Perform steps from the start.

• When you connect the speaker system and TV with an HDMI cable, the BLUETOOTH connection is canceled. To connect the speaker system and TV with the BLUETOOTH function again, disconnect the HDMI cable, then perform the connecting operation from the start.

Listening to Sound of the Paired TV

- Turn on the TV with the TV remote control. The speaker system is turned on by interlocking with the TV power and TV sound is output from the speaker system.
- Select the program or input of the device by using the TV remote control. The sound of the displayed image on the TV screen is output from the speaker system.
- Adjust the volume of the speaker system by using the TV remote control. When pressing the muting button on the TV remote control, the sound is muted temporarily.

Tip
 When the TV is turned off, the speaker system is also turned off by interlocking with the TV power.

About operations with the remote control that is supplied with the speaker system
 You can use the following buttons.

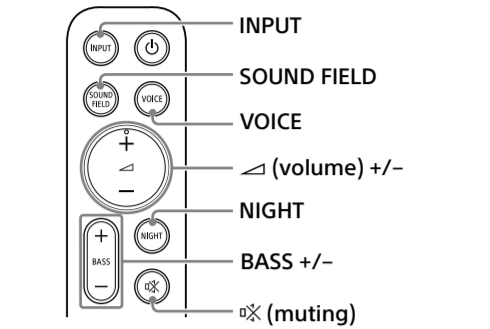

Note
 If you select the BLUETOOTH input on the remote control supplied with the speaker system, the TV sound is not output from the speaker system. To output the TV sound, press INPUT on the remote control to change to the TV input.



Adjusting the Sound

Enjoying Surround Effect (SOUND FIELD)

You can turn the surround effect on or off to suit sound sources.

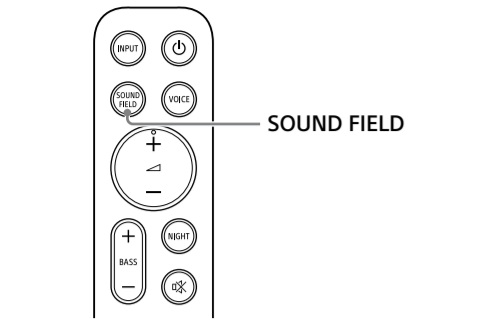

1	Press SOUND FIELD to select the setting. The setting appears in the front panel display.
Setting	Explanation
[SF.ON]	The sound is output with the surround effect. This setting is suitable for experiencing the surround sound with presence.
[SF.OFF]	The sound is output without the surround effect. This setting is suitable for listening to music or news.

Making Dialogs Clearer (VOICE)

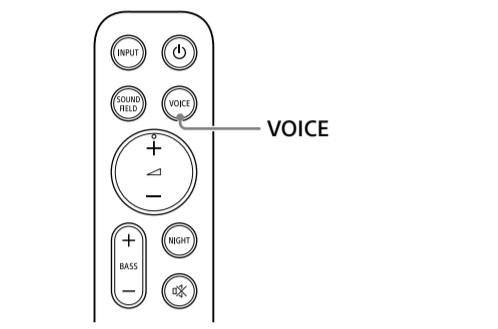

1	Press VOICE to select the setting. The setting appears in the front panel display.
Setting	Explanation
[Vo.ON]	Dialog is easily heard by enhancing dialog range.
[Vo.OFF]	Deactivates the voice mode function.

Enjoying Clear Sound with Low Volume at Midnight (NIGHT)

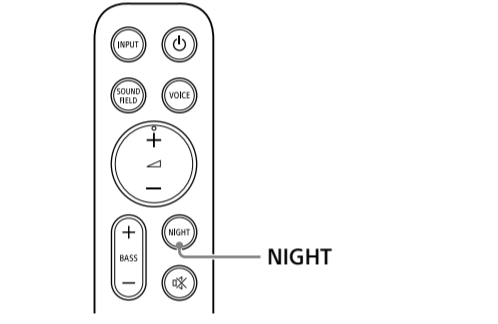

1	Press NIGHT to select the setting. The setting appears in the front panel display.
Setting	Explanation
[N.ON]	Sound is output at low volume with minimum loss of fidelity and clarity of dialog.
[N.OFF]	Deactivates the night mode function.

Note
When you turn the speaker system off, this setting is set to [N.OFF] automatically.

Using the Speaker System by Interlocking with a TV

Operating the Speaker System by Interlocking with a TV (Control for HDMI Function)

Connecting a TV compatible with the Control for HDMI function using an HDMI cable enables you to interlock the speaker system operation such as power on/off or volume adjustment with a TV.

About the Control for HDMI function

The Control for HDMI function is a function that enables operation of devices connected with an HDMI (High-Definition Multimedia Interface) cable by interlocking them.

Although this function works for devices compatible with the Control for HDMI function, it may not work if connecting devices other than those manufactured by Sony.

Preparing to Operate by Interlocking with a TV

Enable the Control for HDMI function settings of the TV connected to the speaker system with an HDMI cable.

The default setting of the Control for HDMI function of the speaker system is [ON].

Tips

- When connecting a device such as a Blu-ray Disc player to a TV with an HDMI cable, enable its Control for HDMI function.
- To enable the Control for HDMI function of a TV or Blu-ray Disc player, refer to their operating instructions.
- If you enable the Control for HDMI ("BRAVIA Sync") function when using a TV manufactured by Sony, the Control for HDMI function of the speaker system is also enabled automatically. When the setting is complete, [DONE] appears in the front panel display.

Performing Power Operation or Volume Adjustment by a TV Remote Control

When turning the TV on/off or adjusting the volume using the TV remote control, the speaker system power operation or volume adjustment is interlocked.

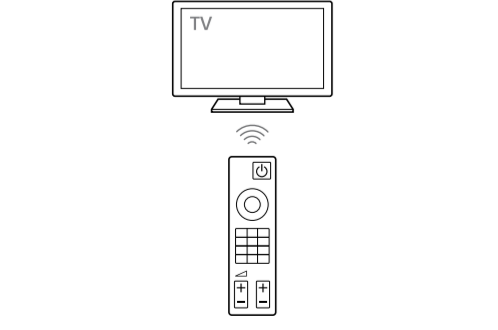

Power interlocking

When you turn on or off the TV, the speaker system will turn on or off automatically.

Note
If you turn off the speaker system before turning off the TV, the speaker system may not turn on automatically even though you turn on the TV next time. In this case, perform the following operation.
– Select the speaker system for the sound output device in the TV menu.
– When using Sony TV, turn on the speaker system while the TV is turned on.

Volume adjustment

The sound of the TV you are watching is output from the speaker system automatically. You can adjust the speaker system volume by the TV remote control.

Tip
You can change the Control for HDMI settings by following procedure.

- Press and hold **VOICE** on the remote control for more than 5 seconds. [CONTROL FOR HDMI] appears in the front panel display.
- Press **↔** (volume) +/- on the remote control to display the desired setting in the front panel display.
- Wait until the displayed setting disappears from the front panel display. The setting is fixed.

Operating the Speaker System by Interlocking with a TV Compatible with the "BRAVIA" Sync Function

"BRAVIA" Sync is an extended function developed by Sony based on the Control for HDMI function. By connecting "BRAVIA" Sync-compatible devices such as a TV using an HDMI cable, you can control the devices by interlocking them with each other.

To use "BRAVIA" Sync
"BRAVIA" Sync is enabled by enabling the Control for HDMI function of the Sony device. For the operation to enable the Control for HDMI function, see "Preparing to Operate by Interlocking with a TV."

What You Can Do with "BRAVIA" Sync

Control for HDMI function

- Power interlocking
- Volume adjustment

Saving Power Consumption

To use the speaker system with saving power consumption, change the following settings.

Turning the Speaker System Off by Detecting the Using State

When you set the auto standby function to on, the speaker system enters standby mode automatically when you do not operate the speaker system for about 20 minutes and the speaker system is not receiving an input signal.

- Press and hold **⏻** (power) and **□** (TV) on the bar speaker for more than 5 seconds. [AUTO STANDBY] and the current setting appear in the front panel display.
- Press **↔** (volume) +/- on the remote control to display the desired setting in the front panel display.
- Wait until the displayed setting disappears from the front panel display. The setting is fixed.

Saving Power in Standby Mode

To save power consumption during the standby mode, set the BLUETOOTH standby mode and Control for HDMI function to off.

To change the BLUETOOTH standby mode setting, press and hold **⏻** (power), **⌘** (BLUETOOTH), and **↔** (volume) on the bar speaker for more than 5 seconds (the changed setting appears in the front panel display).

To change the Control for HDMI function setting, press and hold **VOICE** on the remote control for more than 5 seconds to display the setting in the front panel display, then press **↔** (volume) +/- on the remote control to select the desired setting.

Changing the Settings

Audio Settings		
Easily listening to low volume sounds.	You can easily listen to low volume sounds by compressing the dynamic range (the range between maximum and minimum volume) of the sound signal by setting to [ON]. This function works only when playing Dolby Digital signal.	<ol style="list-style-type: none">Press and hold ⏻ (power), □ (TV), and ↔ (volume) on the bar speaker for more than 5 seconds. [DRC] and the current setting appear in the front panel display. To change the setting, perform the same operation as step 1. The setting is fixed after the changed setting appears in the front panel display.
Adjusting the volume of the connected device automatically	You can adjust the volume automatically depending on the input signal or contents of a connected device by setting to [ON].	<ol style="list-style-type: none">Press and hold NIGHT on the remote control for more than 5 seconds. [A.VOL] appears in the front panel display. Press ↔ (volume) +/- on the remote control to display the desired setting in the front panel display. Wait until the displayed setting disappears from the front panel display. The setting is fixed.
Selecting the sound for multiplex broadcast	You can select the sound for multiplex broadcast.	<ol style="list-style-type: none">Press and hold ⌘ (muting) on the remote control for more than 5 seconds. [DUAL] appears in the front panel display. Press ↔ (volume) +/- on the remote control to display the desired setting in the front panel display. Wait until the displayed setting disappears from the front panel display. The setting is fixed.

BLUETOOTH Settings

Turning the BLUETOOTH standby mode on or off	You can turn the speaker system on and start the BLUETOOTH connection automatically with the BLUETOOTH device operation while the speaker system is in standby mode by setting to [ON].	<ol style="list-style-type: none">Press and hold ⏻ (power), ⌘ (BLUETOOTH), and ↔ (volume) on the bar speaker for more than 5 seconds. [BT STANDBY] and the current setting appear in the front panel display. To change the setting, perform the same operation as step 1. The setting is fixed after the changed setting appears in the front panel display. <p>Notes</p> <ul style="list-style-type: none">While the BLUETOOTH standby mode is on, standby power consumption increases. The BLUETOOTH standby mode cannot be set while the BLUETOOTH function is off.
Turning the BLUETOOTH function on or off	You can turn the BLUETOOTH function on or off.	<ol style="list-style-type: none">Press and hold ⏻ (power) and ⌘ (BLUETOOTH) on the bar speaker for more than 5 seconds. [BT POWER] and the current setting appear in the front panel display. To change the setting, perform the same operation as step 1. The setting is fixed after the changed setting appears in the front panel display.

Turning the BLUETOOTH function on or off	You can turn the BLUETOOTH function on or off.	<ol style="list-style-type: none">Press and hold ⏻ (power) and ⌘ (BLUETOOTH) on the bar speaker for more than 5 seconds. [BT STANDBY] and the current setting appear in the front panel display. To change the setting, perform the same operation as step 1. The setting is fixed after the changed setting appears in the front panel display.
--	--	---

Front Panel Display/Indicators Settings

Adjusting the brightness of the front panel display and indicators	You can change the brightness of the followings. <ul style="list-style-type: none">Front panel display on the bar speaker BLUETOOTH indicator on the bar speaker Power indicator on the subwoofer	<ol style="list-style-type: none">Press and hold □ (TV) and ⌘ (BLUETOOTH) on the bar speaker for more than 5 seconds. [DIMMER] appears in the front panel display. Press ↔ (volume) +/- on the remote control to display the desired setting in the front panel display. Wait until the displayed setting disappears from the front panel display. The setting is fixed. <p>Note The front panel display is turned off when [OFF] is selected. It turns on automatically when you press any button, then turns off again if you do not operate the speaker system for about 10 seconds. In case of that the speaker system cannot be operated without displaying message in the front panel display, the front panel display lights with the brightness of the [DARK] setting.</p>
--	---	--

Other Settings/Functions

Checking the sound settings and software version	You can check the stream information, current settings of the sound field and voice/night modes, and software version.	<ol style="list-style-type: none">Press and hold SOUND FIELD on the remote control for more than 5 seconds. The stream information appears in the front panel display. Press ↔ (volume) +/- on the remote control to display the desired checking item. Each time you press ↔ (volume) – on the remote control, the displayed item changes cyclically as follows. Stream information → Sound field → Voice mode → Night mode → Software version The checking item appears in the reverse order by pressing ↔ (volume) +.
Using the IR repeater function	When the bar speaker obstructs the remote control sensor of the TV, the TV remote control may not work. In that case, enable the IR repeater function of the speaker system. You can control the TV with the TV remote control by sending the remote signal that the bar speaker received to the TV.	<ol style="list-style-type: none">Press and hold ⌘ (BLUETOOTH) and ↔ (volume) on the bar speaker for more than 5 seconds. [IR REPEATER] appears in the front panel display. Press ↔ (volume) +/- on the remote control to display the desired setting in the front panel display. Wait until the displayed setting disappears from the front panel display. The setting is fixed. <p>Note When using the IR repeater function, install the bar speaker apart from the TV screen by 9 cm (3 5/8 in) or more.</p>
Updating the software	Start the software update after connecting the USB memory on which the software update file is stored to the UPDATE port on the bar speaker. For information about the software updates, visit the following website: <ul style="list-style-type: none">For customers in Americas https://www.sony.com/am/support For customers in Europe https://www.sony.eu/support For customers in Asia-Pacific, Oceania, Middle East, and Africa https://www.sony-asia.com/support	<ol style="list-style-type: none">Connect the USB memory on which the software update file is stored to the UPDATE port on the bar speaker. Press and hold ⏻ (power), ⌘ (BLUETOOTH), and + (volume) on the bar speaker for more than 5 seconds. [UPDATE] appears in the front panel display and the software update starts. <p>Note Before updating, make sure the following. <ul style="list-style-type: none">Select the TV input by pressing INPUT. Increase the volume on the TV or cancel muting. Depending on the order in which you turn on the TV and the speaker system, the speaker system may be muted. If this happens, turn on the TV first, then the speaker system. Set the speakers setting of the TV (BRAVIA) to Audio System. Refer to the operating instructions of your TV regarding how to set the TV. Check the sound output of the TV. Refer to the operating instructions of the TV for the TV settings. The speaker system supports the Dolby Digital and PCM audio formats. When you playback an unsupported format, set the digital audio output setting of the TV (BRAVIA) to "PCM." For details, refer to the operating instructions of your TV.</p>

Troubleshooting

Troubleshooting

If the speaker system does not work properly, handle it in the following order.

- Search for the **cause and solution of the issue** using this troubleshooting.
- Reset the speaker system.**

All the settings of the speaker system return to their initial status. For details, see "Resetting the Speaker System."

Should any problems persist, consult your nearest Sony dealer.

Power

The speaker system does not power up.

- Check that the AC power cord (mains lead) is connected securely.
- Disconnect the AC power cord (mains lead) from the wall outlet (mains), and then reconnect after several minutes.

The speaker system is turned off automatically.

- The auto standby function is working. Press and hold **⏻** (power) and **□** (TV) on the bar speaker for more than 5 seconds to display [AUTO STANDBY] in the front panel display, then press **↔** (volume) +/- on the remote control to display [OFF] in the front panel display.

The speaker system does not turn on even when the TV is turned on.

- Set the Control for HDMI function to on. Press and hold **VOICE** on the remote control for more than 5 seconds to display [CONTROL FOR HDMI] in the front panel display, then press **↔** (volume) +/- on the remote control to display [ON] in the front panel display. The TV must support the Control for HDMI function. For details, refer to the operating instructions of your TV.
- Check the speaker settings of the TV. The speaker system power syncs with the speaker settings of the TV. For details, refer to the operating instructions of your TV.

- Depending on the TV, if the sound was output from the speakers of the TV the previous time, the speaker system may not turn on by interlocking with the TV power even when the TV is turned on.

The speaker system turns off when the TV is turned off.

- Check the setting of the Control for HDMI function by pressing and holding **VOICE** on the remote control for more than 5 seconds to display [CONTROL FOR HDMI] in the front panel display. To change the setting, press **↔** (volume) +/- on the remote control. When the Control for HDMI function is set to on and the input of the speaker system is the TV input, the speaker system turns off automatically when you turn off the TV.

The speaker system does not turn off even when the TV is turned off.

- Check the setting of the Control for HDMI function by pressing and holding **VOICE** on the remote control for more than 5 seconds to display [CONTROL FOR HDMI] in the front panel display. To change the setting, press **↔** (volume) +/- on the remote control. When you turn off the TV, the speaker system turns off automatically only if the input of the speaker system is the TV input. The TV must support the Control for HDMI function. For details, refer to the operating instructions of your TV.

Picture

There is no picture or the picture is not output correctly.

- When there is no picture while TV input is selected, select the TV channel that you want using the TV remote control.

Sound

The speaker system cannot connect to a TV with the BLUETOOTH function.

- When you connect the speaker system and TV with an HDMI cable (not supplied), the BLUETOOTH connection is canceled. Disconnect the HDMI cable, then perform the connecting operation from the start.

No TV sound is output from the speaker system.

- Check the type and connection of the HDMI cable or optical digital cable that is connected to the speaker system and the TV (refer to the supplied Startup Guide).

- Disconnect the cables that are connected between the TV and the speaker system, then connect them firmly again. Disconnect the AC power cords of the TV and the speaker system from the AC outlets (mains), then connect them again.
- When the speaker system and TV are connected with an HDMI cable only, check the following.
 - The HDMI jack of the connected TV is labeled with "ARC."
 - The Control for HDMI function of the TV is set to on.
 - On the speaker system, the Control for HDMI function is set to on. Press and hold **VOICE** on the remote control for more than 5 seconds to display [CONTROL FOR HDMI] in the front panel display, then press **↔** (volume) +/- on the remote control to display [ON] in the front panel display.

- If your TV is not compatible with ARC, connect the optical digital cable (supplied) (refer to the supplied Startup Guide). If the TV is not compatible with ARC, TV sound will not be output from the speaker system even if the speaker system is connected to the TV's HDMI IN jack.
- Select the TV input by pressing INPUT.
- Increase the volume on the TV or cancel muting.
- Depending on the order in which you turn on the TV and the speaker system, the speaker system may be muted. If this happens, turn on the TV first, then the speaker system.
- Set the speakers setting of the TV (BRAVIA) to Audio System. Refer to the operating instructions of your TV regarding how to set the TV.
- Check the sound output of the TV. Refer to the operating instructions of the TV for the TV settings.

The sound is output from both the speaker system and the TV.

- Change the audio output setting of the TV so that the TV sound is output from the external speaker.
- Set the TV volume to minimum.

The output sound of the speaker system is not the same level as that of the TV even though the values of the volume level on the speaker system and TV are set to the same value.

- If the Control for HDMI function is set to on, the value of the volume level on the speaker system may appear on your TV as the TV volume. The output sound levels of the speaker system and TV differ even though the values of the volume level on the speaker system and TV are set to the same value. The output sound levels of the speaker system and TV differ depending on the sound processing characteristics of each, and it is not a malfunction.

The surround effect cannot be obtained.

- Depending on the input signal and the sound field setting, surround sound processing may not work effectively. The surround effect may be subtle, depending on the program or disc.

- To play multi channel audio, check the digital audio output setting on the device connected to the TV.

the speaker system. For details, see the operating instructions of the connected device.

Subwoofer

No sound or only very low-level sound is heard from the subwoofer.

- Press **BASS +** on the remote control to increase the subwoofer volume.
- Make sure that the power indicator on the subwoofer is lit in green or amber.
- If the power indicator on the subwoofer does not light, try the following.
 - Make sure the AC power cord (mains lead) of the subwoofer is connected properly.
 - Press **⏻** (power) of the subwoofer to turn on the power.
- If the power indicator on the subwoofer lights in red, try the following.
 - Move the subwoofer to a location near the bar speaker so that the power indicator on the subwoofer lights in green or amber.
 - Follow the steps in "Connecting the Subwoofer Manually."
- If the power indicator on the subwoofer flashes in red, press **⏻** (power) of the subwoofer to turn off the power and check whether the ventilation holes of the subwoofer is blocked or not.
- If the input sources contain very little bass sound components (i.e., a TV broadcast), the sound from the subwoofer may be difficult to hear. Play the built-in demonstration music by following the steps below and check that the sound is output from the subwoofer.
 - Press and hold **□** (TV) on the bar speaker for 5 seconds.
 - The built-in demonstration music is played.
 - Press **□** (TV) again.
 - The built-in demonstration music is canceled and the speaker system returns to TV input.
 - Set the night mode to off by pressing NIGHT.

BASS +/- does not work and [NOT USE] appears in the front panel display.

- BASS +/- does not work when the subwoofer is not connected. Check the power and connection status of the subwoofer.

Mobile Device Connection

BLUETOOTH connection cannot be completed.

- Make sure that the BLUETOOTH indicator on the bar speaker is lit.
- Make sure the BLUETOOTH device to be connected is turned on and the BLUETOOTH function is enabled.
- Bring the BLUETOOTH device close to the bar speaker.
- Pair the speaker system and the BLUETOOTH device again. You may need to cancel the pairing with the speaker system using your BLUETOOTH device first.
- If the BLUETOOTH function is set to off, set it to on. To change the BLUETOOTH function setting, press and hold **⌘** (BLUETOOTH) on the bar speaker for more than 5 seconds (the changed setting appears in the front panel display).

Pairing cannot be achieved.

- Bring the BLUETOOTH device close to the bar speaker.
- Make sure the speaker system is not receiving interference from a wireless LAN device, other 2.4 GHz wireless devices, or a microwave oven. If a device that generates electromagnetic radiation is nearby, move the device away from the speaker system.
- Pairing may not be possible if other BLUETOOTH devices are present around the speaker system. In this case, turn off the other BLUETOOTH devices.

Sound of the connected BLUETOOTH mobile device is not output from the speaker system.

- Make sure that the BLUETOOTH indicator on the bar speaker is lit.
- Bring the BLUETOOTH device close to the bar speaker.
- If a device that generates electromagnetic radiation, such as a wireless LAN device, other BLUETOOTH devices, or a microwave oven is nearby, move the device away from the speaker system.
- Remove any obstacle between the bar speaker and the BLUETOOTH device or move the bar speaker away from the obstacle.
- If the bar speaker is installed under the TV, move the bar speaker away from the TV.
- Reposition the connected BLUETOOTH device.
- Switch the wireless LAN frequency of any nearby wireless LAN router or PC to 5 GHz range.
- Increase the volume on the connected BLUETOOTH device.

The sound is not in sync with the image.

- When you are watching movies, you may hear the sound with a slight delay from the image.

Remote Control

The remote control of the speaker system does not function.

- Point the remote control at the remote control sensor on the bar speaker.
- Remove any obstacles in the path between the remote control and the speaker system.
- Replace both batteries in the remote control with new ones, if they are weak.
- Make sure you are pressing the correct button on the remote control.

The TV remote control does not work.

- Install the bar speaker so that it does not obstruct the remote control sensor of the TV.
- This problem might be solved by enabling the IR repeater function. Press and hold **⌘** (BLUETOOTH) and **↔** (volume) on the bar speaker for more than 5 seconds to display [IR REPEATER] in the front panel display, then press **↔** (volume) +/- on the remote control to display [ON] in the front panel display.

Others

The Control for HDMI function does not work properly.

- Check the connection with the speaker system (refer to the supplied Startup Guide).
- Enable the Control for HDMI function on the TV. For details, refer to the operating instructions of your TV.
- Wait a while, and then try again. If you unplug the speaker system, it will take a while before operation can be made. Wait for 15 seconds or longer, and then try again.
- Make sure the TV connected to the speaker system supports the Control for HDMI function.
- The type and number of devices that can be controlled by the Control for HDMI function is restricted by the HDMI CEC standard as follows:
 - Recording devices (Blu-ray Disc recorder, DVD recorder, etc.): up to 3 devices
 - Playback devices (Blu-ray Disc player, DVD player, etc.): up to 3 devices
 - Tuner-related devices: up to 4 devices
 - Audio system (receiver/headphone): up to 1 device (used by the speaker system)

[PROTECT] is scrolled in the front panel display, then the speaker system is turned off after 5 seconds.

- The protection feature is activated. Disconnect the AC power cord (mains lead) and make sure that the ventilations of the bar speaker are not covered and turn on the speaker system after a while.

Sensors of the TV do not work properly.

- The bar speaker may block some sensors (such as the brightness sensor), the remote control sensor of your TV or the emitter for 3D glasses (infrared transmission) of a 3D TV that supports the infrared 3D glass system, or wireless communication. Move the bar speaker away from the TV within a range that allows those parts to operate properly. For the locations of the sensors and remote control receiver, refer to the operating instructions of the TV.

The speaker system does not work properly.

- The speaker system may be in demo mode. To cancel demo mode, reset the speaker system. Press and hold **⏻** (power) and **↔** (volume) on the bar speaker for more than 5 seconds.

The following message appears.

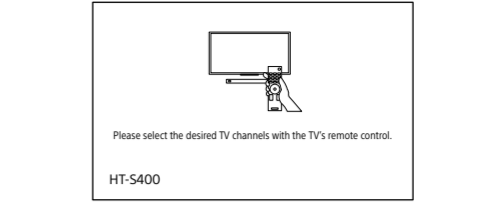

- This screen is an example for English.
- Select the TV program by using the TV remote control.

Resetting the Speaker System

If the speaker system does not operate properly, reset the speaker system as follows.

- Press and hold **⏻** (power) and **↔** (volume) on the bar speaker for more than 5 seconds. [RESET] appears in the front panel display, and the settings return to their initial status.
- Disconnect the AC power cord (mains lead).
- Connect the AC power cord (mains lead), then press **⏻** (power) to turn on the speaker system.

Specifications

Bar Speaker (SA-S400)

Amplifier section
U.S. models:
POWER OUTPUT and TOTAL HARMONIC DISTORTION: (1) Front L + Front R: With 4 ohms loads, both channels driven, from 200 - 20,000 Hz, rated 20 W per channel maximum RMS power with no more than 1% total harmonic distortion from 250 mW to rated output. POWER OUTPUT (reference): Front L/Front R speaker: 100 W (per channel at 4 ohms, 1kHz)

Canadian models:
POWER OUTPUT (rated): Front L + Front R: 60 W + 60 W (at 4 ohms, 1kHz, 1% THD) POWER OUTPUT (reference): Front L/Front R speaker: 100 W (per channel at 4 ohms, 1kHz) Input: TV IN (OPTICAL) Output: TV OUT (TV ARC)

HDMI section
Connector: Type A (19 pin)
USB section
UPDATE port: Type A (For software update only)
BLUETOOTH section
Communication system: BLUETOOTH Specification version 5.0 Output: BLUETOOTH Specification Power Class 1 Maximum communication range: (line of sight approx. 25 m (82 ft) *) Maximum number of devices to be registered: Mobile device: 9 devices Sony TV device: Frequency band: 2.4 GHz band (2,400 GHz - 2,4835 GHz) Modulation method: FHSS (Freq Hopping Spread Spectrum) Compatible BLUETOOTH profiles: A2DP (Advanced Audio Distribution Profile) AVRCP (Audio Video Remote Control Profile) Supported Codes: SBC* *Transmission range (A2DP) 1) 20 Hz - 20,000 Hz (Sampling frequency 32 kHz, 44.1 kHz, 48 kHz) 2) The actual range will vary depending on factors such as