

SONY®

Home Audio System

Operating Instructions

Getting Started

Disc/USB Playback

USB Transfer

Tuner

BLUETOOTH Connection

Sound Adjustment

Other Operations

Additional Information

For the customers in the USA

Owner's Record

The model and serial numbers are located on the rear of the unit. Record these numbers in the spaces provided below. Refer to them whenever you call upon your Sony dealer regarding this product.

Model No. _____

Serial No. _____

WARNING

To reduce the risk of fire or electric shock, do not expose this apparatus to rain or moisture.

To reduce the risk of fire, do not cover the ventilation opening of the appliance with newspapers, tablecloths, curtains, etc.

Do not expose the appliance to naked flame sources (for example, lighted candles).

To reduce the risk of fire or electric shock, do not expose this appliance to dripping or splashing, and do not place objects filled with liquids, such as vases, on the appliance.

As the main plug is used to disconnect the unit from the mains, connect the unit to an easily accessible AC outlet. Should you notice an abnormality in the unit, disconnect the main plug from the AC outlet immediately.

Do not install the appliance in a confined space, such as a bookcase or built-in cabinet.

The unit is not disconnected from the mains as long as it is connected to the AC outlet, even if the unit itself has been turned off.

Indoor use only.

CAUTION

Risk of explosion if the battery is replaced by an incorrect type.

Do not expose batteries or appliances with battery-installed to excessive heat, such as sunshine and fire.

CAUTION

The use of optical instruments with this product will increase eye hazard.

FOR UNITED STATES CUSTOMERS. NOT APPLICABLE IN CANADA, INCLUDING IN THE PROVINCE OF QUEBEC.

POUR LES CONSOMMATEURS AUX ÉTATS-UNIS. NON APPLICABLE AU CANADA, Y COMPRIS LA PROVINCE DE QUÉBEC.

For the customers in the USA



This symbol is intended to alert the user to the presence of uninsulated "dangerous voltage" within the product's enclosure that may be of sufficient magnitude to constitute a risk of electric shock to persons.



This symbol is intended to alert the user to the presence of important operating and maintenance (servicing) instructions in the literature accompanying the appliance.

Important Safety Instructions

- 1) Read these instructions.
- 2) Keep these instructions.
- 3) Heed all warnings.
- 4) Follow all instructions.
- 5) Do not use this apparatus near water.
- 6) Clean only with dry cloth.

- 7) Do not block any ventilation openings. Install in accordance with the manufacturer's instructions.
- 8) Do not install near any heat sources such as radiators, heat registers, stoves, or other apparatus (including amplifiers) that produce heat.
- 9) Do not defeat the safety purpose of the polarized or grounding-type plug. A polarized plug has two blades with one wider than the other. A grounding type plug has two blades and a third grounding prong. The wide blade or the third prong are provided for your safety. If the provided plug does not fit into your outlet, consult an electrician for replacement of the obsolete outlet.
- 10) Protect the power cord from being walked on or pinched particularly at plugs, convenience receptacles, and the point where they exit from the apparatus.
- 11) Only use attachments/accessories specified by the manufacturer.
- 12) Use only with the cart, stand, tripod, bracket, or table specified by the manufacturer, or sold with the apparatus. When a cart is used, use caution when moving the cart/apparatus combination to avoid injury from tip-over.



- 13) Unplug this apparatus during lightning storms or when unused for long periods of time.

- 14) Refer all servicing to qualified service personnel. Servicing is required when the apparatus has been damaged in any way, such as power-supply cord or plug is damaged, liquid has been spilled or objects have fallen into the apparatus, the apparatus has been exposed to rain or moisture, does not operate normally, or has been dropped.

NOTE:

This equipment has been tested and found to comply with the limits for a Class B digital device, pursuant to Part 15 of the FCC Rules. These limits are designed to provide reasonable protection against harmful interference in a residential installation. This equipment generates, uses and can radiate radio frequency energy and, if not installed and used in accordance with the instructions, may cause harmful interference to radio communications. However, there is no guarantee that interference will not occur in a particular installation. If this equipment does cause harmful interference to radio or television reception, which can be determined by turning the equipment off and on, the user is encouraged to try to correct the interference by one or more of the following measures:

- Reorient or relocate the receiving antenna.
- Increase the separation between the equipment and receiver.
- Connect the equipment into an outlet on a circuit different from that to which the receiver is connected.
- Consult the dealer or an experienced radio/TV technician for help.

CAUTION

You are cautioned that any changes or modifications not expressly approved in this manual could void your authority to operate this equipment.

Properly shielded and grounded cables and connectors must be used for connection to host computers and/or peripherals in order to meet FCC emission limits.

This equipment must not be co-located or operated in conjunction with any other antenna or transmitter.

This equipment complies with FCC radiation exposure limits set forth for an uncontrolled environment and meets the FCC radio frequency (RF) Exposure Guidelines. This equipment should be installed and operated keeping the radiator at least 20 cm or more away from person's body.

For the customers in Canada

Properly shielded and grounded cables and connectors must be used for connection to host computers and/or peripherals.

This device complies with Industry Canada's licence-exempt RSSs. Operation is subject to the following two conditions:
(1) This device may not cause interference; and
(2) This device must accept any interference, including interference that may cause undesired operation of the device.

This equipment complies with IC radiation exposure limits set forth for an uncontrolled environment and meets RSS-102 of the IC radio frequency (RF) Exposure rules. This equipment should be installed and operated keeping the radiator at least 20 cm or more away from person's body.

License and Trademark Notice

- "CD" logo is trademark.
- WALKMAN® and WALKMAN® logo are registered trademarks of Sony Corporation.
- MPEG Layer-3 audio coding technology and patents licensed from Fraunhofer IIS and Thomson.
- Windows Media is either a registered trademark or trademark of Microsoft Corporation in the United States and/or other countries.
- This product is protected by certain intellectual property rights of Microsoft Corporation. Use or distribution of such technology outside of this product is prohibited without a license from Microsoft or an authorized Microsoft subsidiary.
- LDAC™ and LDAC logo are trademarks of Sony Corporation.
- The BLUETOOTH® word mark and logos are registered trademarks owned by the Bluetooth SIG, Inc. and any use of such marks by Sony Corporation is under license. Other trademarks and trade names are those of their respective owners.
- The N-Mark is a trademark or registered trademark of NFC Forum, Inc. in the United States and in other countries.
- Android is a trademark of Google LLC.
- Google Play and the Google Play logo are trademarks of Google LLC.
- Apple, iPhone, and iPod touch are trademarks of Apple Inc., registered in the U.S. and other countries. App Store is a service mark of Apple Inc., registered in the U.S. and other countries.

- Use of the Made for Apple badge means that an accessory has been designed to connect specifically to the Apple product(s) identified in the badge, and has been certified by the developer to meet Apple performance standards. Apple is not responsible for the operation of this device or its compliance with safety and regulatory standards.
- All other trademarks are trademarks of their respective owners.
- In this manual, ™ and ® marks are not specified.

About this manual

- This manual mainly explains operations using the remote control, but the same operations can also be performed using the buttons on the unit having the same or similar names.
- Icons, such as , listed at the top of each explanation indicate the type of media that can be used with the function being explained.
- Some illustrations are presented as conceptual drawings, and may be different from the actual products.
- The text enclosed in double quotation mark ("--") appears on the display.

Table of Contents

About this manual	5
Unpacking	8
Playable discs or files on discs/USB device	8
Websites for compatible devices	10
Guide to parts and controls	11

Getting Started

Hooking up the system securely	15
Deactivating the demonstration	16
Inserting batteries	16
Listening to TV sound via the system	17
Changing the display mode	18

Disc/USB Playback

Before using the USB device	18
Basic playback	18
Using play mode	19
Viewing information on the display	20

USB Transfer

Before using the USB device	20
Transferring music	20

Tuner

Listening to the radio	23
------------------------------	----

BLUETOOTH Connection

About the BLUETOOTH wireless technology	24
Pairing this system with a BLUETOOTH device	25
Listening to music on a BLUETOOTH device	26
Connecting this system with multiple BLUETOOTH devices (Multi-device connection)	27
One Touch BLUETOOTH Connection by NFC	27
Setting the BLUETOOTH audio codecs	28
Setting the BLUETOOTH standby mode	29
Turning on or off the BLUETOOTH signal	29
Controlling the system using a smartphone or tablet (Sony Music Center)	30
Getting frenzied parties with the "Fiestable" app	31
Achieving and sharing a Party People ranking and getting bonus features with Party King	31

Sound Adjustment

Adjusting the sound	32
Selecting the Virtual Football mode.....	32
Creating your own sound effect	32
Creating a party atmosphere (DJ Effect)	33

Other Operations

Enjoying wired playback using multiple systems (Wired Party Chain function)	34
Enjoying wireless playback using multiple systems (Wireless Party Chain function)	37
Listening to music wirelessly with two systems (Speaker Add function).....	39
Singing along: Karaoke	41
Enjoying sound from a guitar.....	42
Enjoying music with the Speaker Light	42
Using the Sleep Timer	43
Using the Voice Guidance....	43
Using optional equipment...	43
Deactivating the buttons on the unit (Child Lock)	44
Setting the automatic standby function.....	44
Updating the software.....	45

Additional Information

Troubleshooting	45
Precautions.....	51
Specifications.....	53

Unpacking

- This unit (MHC-V21) (1)
- Remote control (1)
- R03 (size AAA) batteries (2)
- FM lead antenna (1)
- AC power cord (mains lead) (1)

Playable discs or files on discs/USB device

Playable discs

- AUDIO CD
- CD-R/CD-RW in AUDIO CD format

Playable files on discs

MP3 files (.mp3)¹⁾²⁾

Playable files on USB device

MP3 files (.mp3)¹⁾²⁾, WMA files (.wma)²⁾, AAC files (.m4a/.mp4/.3gp)²⁾, WAV files (.wav)²⁾

Note

- The CD-ROM/-R/-RW must be in DATA CD format that contains the MP3¹⁾²⁾ files, and conforms to ISO 9660³⁾ Level 1/Level 2 or Joliet (extended format).
- The system will attempt to play back any data with the extensions above, even if it is not in the supported format. Playing this data may generate a loud noise which could damage your speaker system.

¹⁾ MP3 (MPEG 1 Audio Layer 3) is a standard format defined by ISO/MPEG for compressed audio data. MP3 files must be in MPEG 1 Audio Layer 3 format.

²⁾ Files with copyright protection (Digital Rights Management) cannot be played back by the system.

³⁾ A logical format of files and folders on CD-ROMs, defined by ISO (International Organization for Standardization).

Discs/files that cannot be played back

- You cannot play back the following discs
 - Data part of CD-Extra or Mixed Mode CDs*
 - CD Graphics disc
 - Super Audio CDs
 - DATA CD that is created in Packet Write format
 - DATA CD which has not been correctly finalized
 - A disc that has a non-standard shape (e.g., heart, square, star)
 - A disc that has adhesive tape, paper, or a sticker attached to it
- You cannot play back the following files
 - A WMA file in WMA DRM, WMA Lossless, or WMA PRO format.
 - An AAC file in AAC DRM or AAC Lossless format.
 - The AAC files which is encoded at 96 kHz.
 - Files that are encrypted or protected by passwords.
 - Files with DRM (Digital Rights Management) copyright protection.
- The MP3 PRO audio file can be played back as MP3 file.

* Mixed Mode CD: This format records data on the first track and audio (AUDIO CD data) on the second and subsequent tracks of a session.

Notes on CD-R/-RW

In some cases, a CD-R/-RW cannot be played back on this system due to the recording quality or physical condition of the disc, or the characteristics of the recording device and authoring software. For more information, refer to the operating instructions of the recording device.

Notes on discs

- This product is designed to play back discs that conform to the Compact Disc (CD) standard.
- DualDisc and some music discs encoded with copyright protection technologies do not conform to the CD standard. Therefore, these discs may not be compatible with this product.

Note on multisession disc

- This system can play back multisession discs when an MP3 file is contained in the first session. Any subsequent MP3 files recorded in later sessions can also be played back (If later sessions contain AUDIO CD format, the system cannot play back this multisession discs).
- If the first session is recorded in AUDIO CD format, only the first session will be played back.

Notes on playable files

- Playback may take a longer time to start when:
 - a DATA CD/USB device is recorded with a complicated tree structure.
 - the audio files in another folder have just been played back.
- The system can play back a DATA CD or a USB device in the following conditions:
 - up to a depth of 8 folders
 - up to 300 folders
 - up to 999 files in a disc
 - up to 2,000 files in a USB device
 - up to 650 files in a folderThese numbers may vary depending on the file or folder configuration.
- Folders that have no audio files are skipped.

- Files transferred by a device such as a computer may not be played back in the order in which they were transferred.
- The playback order may not be applicable depending on the software used for creating the audio file.
- Compatibility with all encoding/writing software of the supported formats, recording devices, and recording media cannot be guaranteed.

Notes about USB devices

- This system is not guaranteed to operate with all USB devices.
- Although there are a variety of complex functions for USB devices, the playable contents of USB devices connected to the system are music contents only. For details, refer to the operating instructions of the USB device.
- When a USB device is inserted, the system reads all the files on the USB device. If there are many folders or files on the USB device, it may take a long time to finish reading the USB device.
- Do not connect the system and the USB device through a USB hub.
- With some connected USB devices, there may be a delay before an operation is performed by this system.
- The playback order for the system may differ from the playback order of the connected USB device.
- Before using a USB device, make sure that no virus-ridden files are on the USB device.

Websites for compatible devices

Check the websites below for the latest information about compatible USB and BLUETOOTH devices.

For customers in the United States:

<<https://esupport.sony.com/US/>>

For customers in Canada:

<<http://esupport.sony.com/CA/>>

Compatible iPhone/iPod models

The compatible iPhone/iPod models are as follows. Update your iPhone/iPod with the latest software before using with the system.

Made for

- iPhone X
- iPhone 8
- iPhone 8 Plus
- iPhone 7
- iPhone 7 Plus
- iPhone SE
- iPhone 6s
- iPhone 6s Plus
- iPhone 6
- iPhone 6 Plus
- iPhone 5s
- iPhone 5c
- iPhone 5
- iPhone 4s
- iPod touch (6th generation)
- iPod touch (5th generation)

Guide to parts and controls

You can lock the buttons except  (power) on the unit to prevent them from being operated by mistake (page 44).

Unit

Top

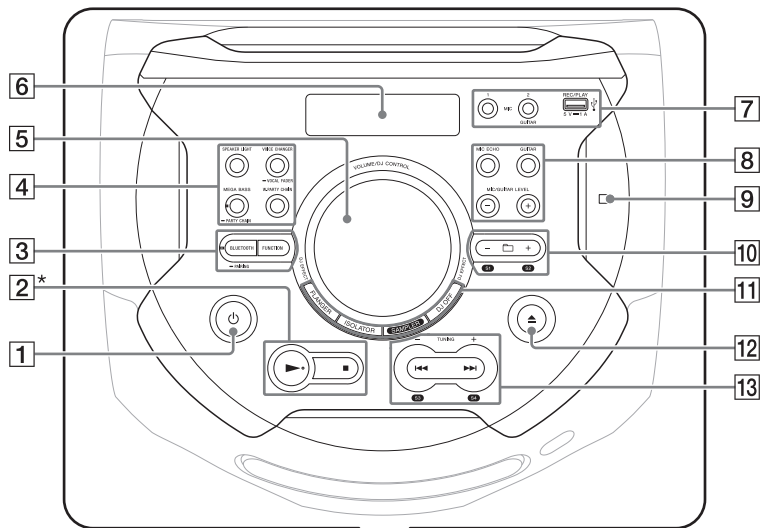

Front

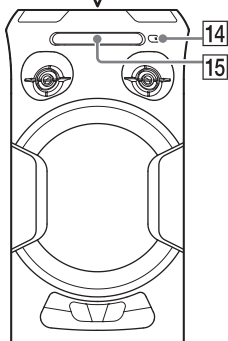



* The  button has a tactile dot. Use the tactile dot as a reference when operating the system.

1  (power)

Turns on the system, or sets it to standby mode.

2  (play)

- Starts playback.
- Hold down  for more than 2 seconds, the built-in sound demonstration will be played back. Press  to stop the demonstration.

 (stop)

- Stops playback. When pressed twice, resume playback can be canceled.
- Stops transfer during music transfer.
- Stops the built-in sound demonstration.

3 **BLUETOOTH indicator**
(page 24)

BLUETOOTH (page 26, 27)

– PAIRING

Hold down to activate BLUETOOTH pairing during the BLUETOOTH function.

FUNCTION

Selects a function.

4 **SPEAKER LIGHT** (page 18, 42, 43)

VOICE CHANGER (page 42)

– VOCAL FADER (page 41)

W.PARTY CHAIN (Wireless Party Chain) (page 38)

MEGA BASS (page 32)

MEGA BASS indicator

Lights up when MEGA BASS sound effect is selected.

– PARTY CHAIN (page 36)

5 **VOLUME/DJ CONTROL knob**

Adjusts the volume.*
Adjusts the FLANGER and ISOLATOR effect or outputs the SAMPLER sound effect continuously (page 33).

* You cannot use this knob to adjust the volume when DJ Effect is selected.

6 **Display**

7 **MIC1 jack**

Use to connect the microphone.

MIC2/GUITAR jack

Use to connect the microphone or guitar.

 (USB) REC/PLAY port

Use to connect a USB device. This port can be used for both playback and music transfer.

8 **MIC ECHO** (page 41)

GUITAR (page 41)

MIC/GUITAR LEVEL +/-
(page 42)

9  (N-Mark) (page 28)

10  +/- (select folder)

Selects a folder on a data disc or a USB device.

S1, S2 (page 33)

11 FLANGER (page 33)

ISOLATOR (page 33)

SAMPLER (page 33)

DJ OFF (page 33)

12 ▲ (open/close)

Opens or closes the disc tray.

13 ◀◀/▶▶ (go backward/go forward) (page 19)

TUNING +/- (page 23)

S3, S4 (page 33)

14 Remote control sensor (page 16)

15 Disc tray

Remote control

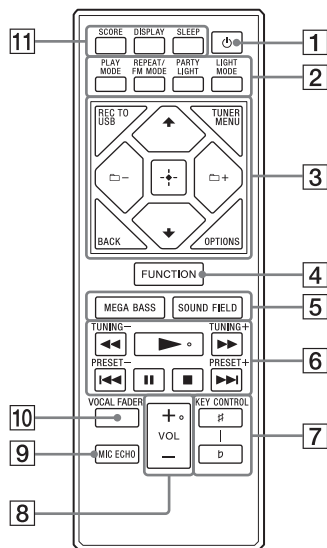

1 (power)

Turns on the system, or sets it to standby mode.

2 PLAY MODE (page 19, 21)

REPEAT/FM MODE
(page 20, 23)

PARTY LIGHT (page 18,
42, 43)

LIGHT MODE (page 43)

3 REC TO USB

Transfers music to the USB device connected to the Ψ (USB) port.

TUNER MENU (page 24)

BACK

Returns to the previous display.

OPTIONS

Enters or exits options menu.



Selects the menu items.



Selects a folder on a data disc or a USB device.



Enters or confirms the settings.

4 FUNCTION

Selects a function.

5 MEGA BASS (page 32)

SOUND FIELD (page 32)

6 ◀◀/▶▶ (fast reverse/fast forward) (page 19)

TUNING+/- (page 23)



Starts playback.

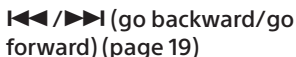

PRESET+/- (page 24)



Pauses playback. To resume playback, press ▶.



- Stops playback.
When pressed twice, resume playback can be canceled.
- Stops transfer during music transfer.
- Stops the built-in sound demonstration.

7 KEY CONTROL #/b (page 41)

8 VOL (volume) +/-*

Adjusts the volume.

9 MIC ECHO (page 41)

10 VOCAL FADER (page 41)

11 SCORE (page 42)

DISPLAY (page 16, 18, 20, 25)

Changes the information on the display.

SLEEP (page 43)

* The ▶ and VOL + buttons have a tactile dot. Use the tactile dot as a reference when operating the system.

Hooking up the system securely

Unit (Rear)

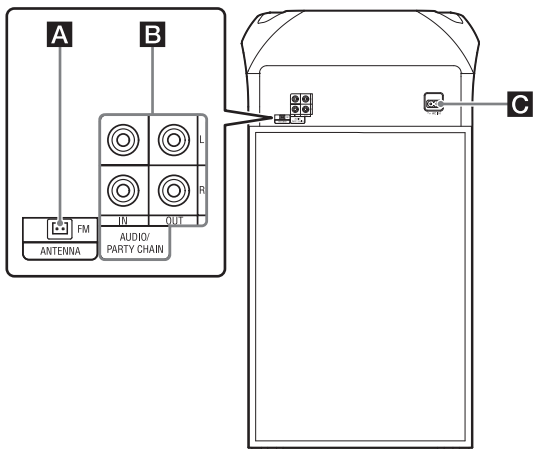

A FM ANTENNA terminal

Find a location and an orientation that provide good reception when you set up the antenna. Keep the antenna away from the AC power cord (mains lead) and the USB cable to avoid picking up noise.

Extend the FM lead antenna horizontally



B Audio input and output jacks

Use an audio cable (not supplied) to make either connection as follows:

- **AUDIO/PARTY CHAIN IN L/R jacks**
 - Connect to the audio output jacks of a TV or an audio/video equipment. The sound is output through this system.
 - Connect to another audio system to enjoy the Wired Party Chain function (page 34).

- **AUDIO/PARTY CHAIN OUT L/R jacks**

- Connect to the audio input jacks of an optional equipment.
- Connect to another audio system to enjoy the Wired Party Chain function (page 34).

G AC power cord (mains lead)

Connect the AC power cord (mains lead) (supplied) to the unit, then to the wall outlet.



The demonstration (page 18) starts automatically. If you press  (power) to turn on the system, the demonstration ends.

Deactivating the demonstration

To deactivate the demonstration while the system is turned off, press DISPLAY repeatedly to select the no display mode (Power Saving Mode) (page 18).

Inserting batteries

Insert the two supplied R03 (size AAA) batteries, matching the polarities shown below.

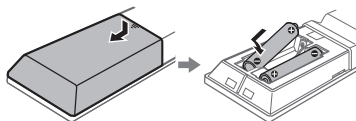

Note

- Do not mix an old battery with a new one or mix different types of batteries.
- If you do not use the remote control for a long period of time, remove the batteries to avoid damage from battery leakage and corrosion.

To operate the system using the remote control

Point the remote control at the unit's remote control sensor.

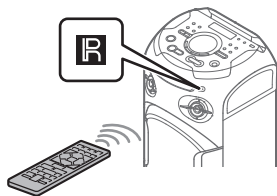

Listening to TV sound via the system

Before connecting cables, be sure to disconnect the AC power cord (mains lead).

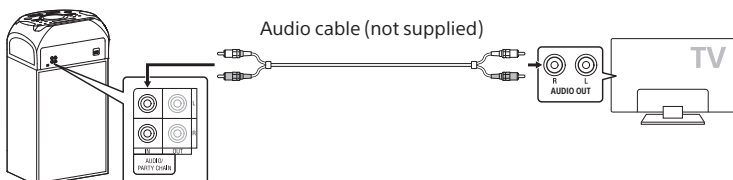

To listen to TV sound, press FUNCTION repeatedly to select "AUDIO IN".

Hint

- You can also enjoy the sound of external equipment (DVD players, etc.) via the system by connecting to the AUDIO/PARTY CHAIN IN L/R jacks. For details, refer to the operating instructions of your equipment.
- If the audio output level from the system is low when connecting the external equipment, try adjusting the audio output settings on the connected equipment. It may improve the audio output level. For details, refer to the operating instructions of your equipment.

Changing the display mode

Press **DISPLAY** repeatedly while the system is turned off.

Each time you press the button, the display mode changes as follows:

Demonstration

The messages about the main features of this system scrolls across the display and the illumination turns on.

To turn off the illumination, press **PARTY LIGHT** (or **SPEAKER LIGHT** on the unit).

No display (Power Saving Mode)

The display and the illumination are turned off to conserve power.

Disc/USB Playback

Before using the USB device

For compatible USB devices, see “Websites for compatible devices” (page 10).

(You can use your iPhone/iPod with this system via **BLUETOOTH** connection only.)

Basic playback

< D DATA CD USB

- 1 Press **FUNCTION** repeatedly to select “**CD**” or “**USB**”.
- 2 Prepare the playback source.

For CD function:

Press **▲** on the unit to open the disc tray and load a disc with the label facing up on the disc tray.

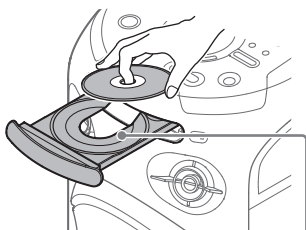

When you play back an 8 cm disc such as a CD single, place it on the inner circle of the tray.

Press **▲** on the unit again to close the disc tray.

Do not forcibly push the disc tray to close it as this may cause a malfunction.

For USB function:

Connect a USB device to the ψ (USB) port.

Note

You can use a USB adaptor (not supplied) to connect the USB device to the unit if the USB device cannot be plugged into the ψ (USB) port.

3 Press \blacktriangleright to start playback.

Other operations

To	Do this
Stop playback	Press \blacksquare .
Pause playback	Press II .
Resume playback or return to normal playback	Press \blacktriangleright .
Cancel the resume point	Press \blacksquare twice.
Select a track or file	Press $\text{I} \lll$ or $\text{III} \ggg$ during playback. (Operation might be prohibited by disc or USB device.)
Locate a point quickly in fast forward or fast reverse (Lock Search)	Press \lll or \ggg during playback.

Using play mode

\lll DATA CD USB

Playing in sequential order (Normal Play)

When playback is stopped, press **PLAY MODE** repeatedly.

The following indicator lights up on the display.

- (None): plays the disc or USB device.
- "FLDR"*: plays all playable files in the specified folder on the disc or USB device.

* Cannot be selected for AUDIO CD.

Playing in random order (Shuffle Play)

When playback is stopped, press **PLAY MODE** repeatedly.

The following indicators light up on the display.

- "SHUF": shuffles all playable files on the disc or USB device.
- "FLDR SHUF"*: shuffles all playable files in the specified folder on the disc or USB device.

* Cannot be selected for AUDIO CD.



Note

- Shuffle Play is canceled when you:
 - open the disc tray.
 - perform Synchronized Transfer.
- Shuffle Play may be canceled when you select a folder or a track to play back.

Playing repeatedly (Repeat Play)

Press REPEAT repeatedly.

The following indicators light up on the display.

- “”: repeats all tracks or audio files on a folder/disc/USB device.
- “”: repeats a track or audio file.

Note

Repeat Play is canceled when you:

- open the disc tray.
- perform Synchronized Transfer.

Viewing information on the display



Press DISPLAY repeatedly when the system is turned on.

You can view the information as follows:

- playing time/remaining time of track, file, disc
- file name, folder name
- title, artist name and album name

Note

- The disc name or track name may not be displayed depending on the characters.
- Playing time of audio files may not be displayed correctly.
- The elapsed playing time for an audio file encoded using a VBR (variable bit rate) is not displayed correctly.

USB Transfer

Before using the USB device

For compatible USB devices, see “Websites for compatible devices” (page 10).

(You can use your iPhone/iPod with this system via BLUETOOTH connection only.)

Transferring music

You can transfer music from a disc (AUDIO CD or MP3 disc only) to a USB device connected to the  (USB) port.

The audio format of files transferred by this system is MP3.

Note

- Do not remove the USB device during transfer or erase operations. Doing so may corrupt the data on the USB device or damage the USB device itself.
- MP3 files are transferred with the same bit rate as the original files.
- When transferring from AUDIO CD, you may select the bit rate before transferring.
- USB transfer and erase operations are prohibited when the disc tray is opened.

Note on copyright-protected content

The transferred music is limited to private use only. Use of the music beyond this limit requires permission of the copyright holders.

To select the bit rate

You can select a higher bit rate to transfer music with better quality.

1 Press OPTIONS.

- 2 Press \uparrow/\downarrow repeatedly to select "BIT RATE", then press $\boxed{+}$.
 - 3 Press \uparrow/\downarrow repeatedly to select the bit rate you want, then press $\boxed{+}$.
 - "128 KBPS": encoded MP3 files have smaller file size and lower audio quality.
 - "256 KBPS": encoded MP3 files have bigger file size but higher audio quality.
- To exit the options menu, press OPTIONS.

Transferring music from a disc

You can transfer music to a USB device connected to Ψ (USB) port as follows:

- Synchronized Transfer: Transfer all tracks or MP3 files from a disc to USB.
- REC1 Transfer: Transfer a single track or MP3 file during playback.

- 1 **Connect a transferable USB device to the Ψ (USB) port on the unit.**

Note

You can use a USB adaptor (not supplied) to connect the USB device to the unit if the USB device cannot be plugged into the Ψ (USB) port.

- 2 Press **FUNCTION** repeatedly to select "CD", then load a disc.

- 3 **Prepare the sound source.**

Synchronized Transfer:

If the system starts playback automatically, press \blacksquare twice to stop the playback fully. When playback is stopped, press **PLAY MODE** repeatedly to select the play mode you want.

Note

If you start transferring in Shuffle Play or Repeat Play, the selected play mode changes to Normal Play automatically.

REC1 Transfer:

Select the track or MP3 file you want to transfer, then start playback.

- 4 Press **REC TO USB**.

"PUSH ENTER" appears on the display.

- 5 Press $\boxed{+}$.

The transfer starts, then "DO NOT REMOVE" appears on the display. Do not remove the USB device until the transfer is complete.

When the transfer is complete, the system performs as follows:

Synchronized Transfer:

The disc stops automatically.

REC1 Transfer:

The disc continues to play the next track or file.

To stop transfer

Press \blacksquare .

Notes on transfer

- While transferring, no sound is output.
- CD-TEXT information is not transferred to the created MP3 files.
- The transfer stops automatically if:
 - the USB device runs out of space during transfer.

- the number of audio files or folders on the USB device reaches the limit that the system can recognize.
- If a folder or file that you are trying to transfer already exists on the USB device with the same name, a sequential number is added after the name without overwriting the original folder or file.
- You cannot perform the following operations during transfer:
 - Eject the disc.
 - Select another track or file.
 - Pause playback or find a point in the track or file.
 - Change the function.
- When transferring music to a WALKMAN® using "Media Manager for WALKMAN", be sure to transfer in MP3 format.
- When connecting a WALKMAN® to the system, be sure to connect after the display "Creating Library" or "Creating Database" on the WALKMAN® has disappeared.

Folder and file generation rules

Maximum number of MP3 files that can be generated

- 298 folders
- 650 files in a folder
- 650 files in REC1-CD or REC1-MP3 folder

These numbers may vary depending on the file or folder configuration.

When transferring to a USB device, a "MUSIC" folder is created directly below "ROOT". Folders and files are generated within this "MUSIC" folder according to the transfer method and source as follows:

Synchronized Transfer

■ When transferring all tracks from an AUDIO CD

Folder name: "CDDA0001"*
File name: "TRACK001"*

■ When transferring MP3 files from a disc

Folder name: Same as the source
File name: Same as the source

REC1 Transfer

■ When transferring a track from an AUDIO CD

Folder name: "REC1-CD"
File name: "TRACK001"*

■ When transferring an MP3 file from a disc

Folder name: "REC1-MP3"
File name: Same as the source

* Folder and file numbers are assigned serially thereafter.

Erasing audio files or folders on the USB device

- 1 Press **FUNCTION** repeatedly to select "USB".
- 2 When playback is stopped, press **OPTIONS**.
- 3 Press **↕/↕** repeatedly to select "ERASE", then press **[+]**.
- 4 Press **↕/↕** repeatedly to select a folder, then press **[+]**.

- 5** Press **↑/↓** repeatedly to select an audio file you want to erase, then press **[+]**.

If you want to erase all the audio files in the folder, select "ALL TRACKS".

"FOLDER ERASE" or "TRACK ERASE" and "PUSH ENTER" appear on the display.

To cancel erase operations, press **■**.

- 6** Press **[+]**.
"COMPLETE" appears on the display. To exit the options menu, press **OPTIONS**.

Note

- You can erase the supported audio file, MP4 format file, and 3GP format file only.
- You cannot erase audio files or folders when Shuffle Play has been selected. Set the play mode to Normal Play before erasing.
- Erase operation is prohibited when the disc tray is opened.

Tuner

Listening to the radio

- 1** Press **FUNCTION** repeatedly to select "TUNER FM".
- 2** Tune to a station.

For automatic scanning:

Hold down **TUNING+/-** until the frequency begins to change on the display.

Scanning stops automatically when a station is tuned in. "ST" (for FM stereo programs only) lights up on the display.

If scanning does not stop, press **■** to stop scanning. Then, perform manual tuning (below).

For manual tuning:

Press **TUNING+/-** repeatedly to tune to the station you want.

Hint

To reduce static noise on a weak FM stereo station, press **FM MODE** repeatedly until "ST" lights off from the display. You will lose the stereo effect, but reception will improve.

Presetting radio stations

You can store up to 20 FM stations as your favorite stations.

- 1 Tune to the station you want.**
- 2 Press TUNER MENU.**
- 3 Press \uparrow/\downarrow repeatedly to select the preset number you want, then press $\boxed{+}$.**

“COMPLETE” appears on the display and the station is stored.

If another station is already assigned to the selected preset number, that station is replaced by the new one.

To listen to the preset station

Press PRESET+/- repeatedly to select the preset number you want.

BLUETOOTH Connection

About the BLUETOOTH wireless technology

BLUETOOTH wireless technology is a short-range wireless technology that enables wireless data communication between digital devices.

Supported BLUETOOTH version, profiles and codecs

For details, see “BLUETOOTH section” (page 54).

Compatible BLUETOOTH devices

For details, see “Websites for compatible devices” (page 10).

About the BLUETOOTH indicator

The BLUETOOTH indicator on the unit lights up or flashes in blue to show the BLUETOOTH status.

System status	Indicator status
BLUETOOTH standby	Flashes slowly
BLUETOOTH pairing	Flashes quickly
BLUETOOTH connection is established	Lights up

Pairing this system with a BLUETOOTH device

Pairing is an operation where BLUETOOTH devices register with each other beforehand. Once a pairing operation is performed, it does not need to be performed again.

If your device is an NFC-compatible BLUETOOTH device, the manual pairing procedure is not necessary. (See “One Touch BLUETOOTH Connection by NFC” on page 27.)

- 1 Place the BLUETOOTH device within 1 meter (3.3 feet) from the unit.**
- 2 Press FUNCTION repeatedly to select the BLUETOOTH function.** “BLUETOOTH” appears on the display.

Hint

- When there is no pairing information on the system (for example, when you use the BLUETOOTH function for the first time after purchase), “PAIRING” flashes on the display and the system enters the pairing mode. Proceed to step 4.
- If the system is connected to a BLUETOOTH device, press BLUETOOTH on the unit to disconnect the BLUETOOTH device.

- 3 Hold down – PAIRING on the unit for 2 seconds or more.** “PAIRING” flashes on the display.

- 4 Turn on the BLUETOOTH function on the BLUETOOTH device and perform the pairing procedure.**

For details, refer to the operating instructions of your BLUETOOTH device.

- 5 Select “MHC-V21” on the display of the BLUETOOTH device.**

Perform this step within 5 minutes, otherwise pairing will be canceled. In this case, repeat from step 3.

Note

If passkey is required on the BLUETOOTH device, enter “0000”. “Passkey” may be called “Passcode”, “PIN code”, “PIN number”, or “Password”.

- 6 Establish connection with the BLUETOOTH device.**

When pairing is completed and the BLUETOOTH connection is established, BLUETOOTH device name appears on the display.

Depending on the BLUETOOTH device, connection may start automatically after pairing is completed.

You can check the BLUETOOTH device address by pressing DISPLAY repeatedly.

Note

- You can pair up to 8 BLUETOOTH devices. If the 9th BLUETOOTH device is paired, the oldest paired device will be deleted.
- If you want to pair with another BLUETOOTH device, repeat steps 1 to 6.

To cancel the pairing operation

Hold down – PAIRING on the unit for 2 seconds or more until “BT AUDIO” appears on the display.

To erase the pairing information

You can erase all pairing information by resetting the system. See “Resetting the system” (page 50).

Note







After you reset the system, it may not be able to connect with your iPhone/iPod. In this case, delete the pairing information of the system on your iPhone/iPod, then perform the pairing operation again.

Listening to music on a BLUETOOTH device

You can listen to music on the BLUETOOTH device and control the playback using the buttons on the unit or the remote control.

Check the following before playing music:

- The BLUETOOTH function of the BLUETOOTH device is turned on.
- Pairing has been completed (page 25).

Once the system and the BLUETOOTH device are connected, you can control playback by pressing , , , /  and / .

1 Press BLUETOOTH on the unit to select the BLUETOOTH function.

“BLUETOOTH” appears on the display.

2 Establish connection with the BLUETOOTH device.

Press BLUETOOTH on the unit to connect to the last connected BLUETOOTH device.

Perform the BLUETOOTH connection from the BLUETOOTH device if the device is not connected.

Once the connection is established, the BLUETOOTH device name appears on the display.

3 Press to start playback.

Depending on the BLUETOOTH device,

- you may need to press  twice.
- you may need to start playing an audio source on the BLUETOOTH device.

4 Adjust the volume.

Adjust the volume of the BLUETOOTH device first. If the volume level is still too low, adjust the volume level on the system.

Note

When the system is not connected to any BLUETOOTH device, the system will connect to the last connected BLUETOOTH device automatically when you press BLUETOOTH or  on the unit.

To terminate the BLUETOOTH connection

Press BLUETOOTH on the unit. “BT AUDIO” appears on the display. Depending on the BLUETOOTH device, the BLUETOOTH connection may be terminated automatically when you stop playback.

Connecting this system with multiple BLUETOOTH devices (Multi-device connection)

You can connect up to three BLUETOOTH devices to the system at the same time with A2DP/AVRCP connection.

Before pairing the next BLUETOOTH device, be sure that the BLUETOOTH function on the system is turned on and the first BLUETOOTH device is connected to the system.

To pair with the second or third device

Repeat steps 1 to 6 of "Pairing this system with a BLUETOOTH device" (page 25).

To switch the playback source

Start playback on another connected BLUETOOTH device while the current device is playing music. The system will output the sound from the latest device.

Note

- Operations may vary depending on the BLUETOOTH device. A BLUETOOTH device may not be connected depending on the combination of the devices. For details, refer to the operating instructions of the device.
- If you try to connect the 4th BLUETOOTH device, the oldest playback device will be disconnected.
- Depending on the BLUETOOTH device, you may not be able to make three BLUETOOTH connections at the same time.

- You cannot establish the multi-device connection when using the Wireless Party Chain function or Speaker Add function.

To disconnect any BLUETOOTH device from the multi-device connection

Terminate the BLUETOOTH connection from the BLUETOOTH device which you want to disconnect.

To disconnect all BLUETOOTH devices from the multi-device connection

Press BLUETOOTH on the unit. "BT AUDIO" appears on the display.

One Touch BLUETOOTH Connection by NFC

NFC (Near Field Communication) is a technology enabling short-range wireless communication between various devices, such as smartphones and IC tags.

When you touch the system with an NFC-compatible BLUETOOTH devices, the system automatically:

- turns on in the BLUETOOTH function.
- completes the pairing and BLUETOOTH connection.

Compatible BLUETOOTH devices

BLUETOOTH devices with a built-in NFC function (OS: Android™ 2.3.3 or later, excluding Android 3.x)

Note

Depending on your NFC-compatible BLUETOOTH device, you may need to turn on the NFC function in advance. For details, refer to the operating instructions of the BLUETOOTH device.

- 1 **Touch the BLUETOOTH device to the N-Mark on the unit until the BLUETOOTH device responds to the system.**

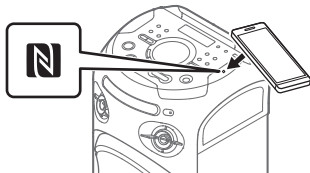

Complete the connection by following the instructions displayed on the BLUETOOTH device.

When the BLUETOOTH connection is established, the BLUETOOTH device name appears on the display.

- 2 **Start playback of an audio source on the BLUETOOTH device.**

For details, refer to the operating instructions of your BLUETOOTH device.

Hint

If pairing and the BLUETOOTH connection fail, do the following.

- Remove the case from the BLUETOOTH device if using a commercially available case.
- Touch the BLUETOOTH device to the N-Mark on the unit again.

To terminate the BLUETOOTH connection

Touch the BLUETOOTH device to the N-Mark on the unit again.

Setting the BLUETOOTH audio codecs

You can enable AAC, LDAC or SBC codec reception from BLUETOOTH device. AAC/LDAC can be selected only when the BLUETOOTH device supports AAC/LDAC.

- 1 **Press OPTIONS.**
- 2 **Press \uparrow/\downarrow repeatedly to select "BT CODEC", then press \square .**

- 3 **Press \uparrow/\downarrow repeatedly to select the setting, then press \square .**

- "AUTO": Enable reception in AAC or LDAC codec format.
- "SBC": Receive in SBC codec format.

To exit the options menu, press OPTIONS.

Note

- You can enjoy high quality sound if AAC or LDAC is selected. If you cannot listen to AAC or LDAC sound from your device or the sound is interrupted, select "SBC".
- If you change this setting while the system is connected to a BLUETOOTH device, the BLUETOOTH device will be disconnected. To connect to the BLUETOOTH device, perform the BLUETOOTH connection again.

Hint

LDAC is an audio coding technology developed by Sony that enables the transmission of High-Resolution (Hi-Res) Audio content, even over a BLUETOOTH connection. Unlike other BLUETOOTH compatible coding technologies such as SBC, it operates without any down-conversion of the Hi-Res Audio content¹⁾, and allows approximately three times more data²⁾ than those other technologies to be transmitted over a BLUETOOTH wireless network with unprecedented sound quality, by means of efficient coding and optimized packetization.

¹⁾ Excluding DSD format contents.

²⁾ In comparison with SBC (Subband Coding) when the bitrate of 990 kbps (96/48 kHz) or 909 kbps (88.2/44.1 kHz) is selected.

Setting the BLUETOOTH standby mode

The BLUETOOTH standby mode enables the system to turn on automatically when you establish a BLUETOOTH connection from a BLUETOOTH device.

1 Press **OPTIONS**.

2 Press **▲/▼** repeatedly to select **"BT STBY"**, then press **[+]**.

3 Press **▲/▼** repeatedly to select the setting, then press **[+]**.

- **"ON"**: The system turns on automatically even when the system is in standby mode.
- **"OFF"**: Turns off this function.

To exit the options menu, press **OPTIONS**.

Turning on or off the BLUETOOTH signal

You can connect to the system from a paired BLUETOOTH device in all functions when the system's BLUETOOTH signal is set to on. The BLUETOOTH signal is turned on by default.

Hold down [] + and MEGA BASS on the unit for about 3 seconds.

"BT ON" or **"BT OFF"** appears on the display.

Note

- You cannot perform the following operations when BLUETOOTH signal is set to off:
 - Pair and/or connect with BLUETOOTH device
 - Use "Sony | Music Center"
 - Change the BLUETOOTH audio codecs
- If you touch the N-Mark on the unit with an NFC-compatible BLUETOOTH device or set the BLUETOOTH standby mode to on, the BLUETOOTH signal will be set to on automatically.



Controlling the system using a smartphone or tablet (Sony | Music Center)

“Sony | Music Center” is a dedicated app for operating “Sony | Music Center”-compatible audio devices manufactured by Sony using a smartphone or tablet. Search for “Sony | Music Center” on Google Play or App Store and download it using your smartphone or tablet. “Sony | Music Center” allows you to:

- change the function of the system, control the playback of the disc/USB device and tune to an FM station.
- browse the music content of disc/USB device.
- view the information of disc/USB device such as playing time and title.
- adjust the volume and change sound setting.
- control multiple systems when using the Wireless Party Chain function.

1 Search for “Sony | Music Center” or scan the two-dimensional code below.



2 Download “Sony | Music Center” app on your device.

3 Connect the system and device via BLUETOOTH connection (page 24).

4 Launch “Sony | Music Center” and follow the on-screen instructions.

Note

- We recommend you to use the latest “Sony | Music Center” version.
- If the “Sony | Music Center” application does not work properly, press BLUETOOTH on the unit to terminate the BLUETOOTH connection, then perform the BLUETOOTH connection again so that the BLUETOOTH connection functions normally.
- Available operations via “Sony | Music Center” may differ depending on the audio devices.
- For more details on “Sony | Music Center”, refer to the following URL. <http://info.vssupport.sony.net/help/>
- Specifications and display design of “Sony | Music Center” are subject to change without notice.



Getting frenzied parties with the “Fiestable” app

You can control the party features of Sony’s Home Audio System with intuitive and fancy user interface with the “Fiestable” app. “Fiestable” allows you to control features such as DJ Effect and Karaoke. You can also enjoy the “Motion Control” function where you can operate certain features on this system by shaking your BLUETOOTH device in different directions. “Fiestable” is a plug-in application of “Sony | Music Center”.

- 1 Search and download “Sony | Music Center” app on your device (page 30).**
- 2 Search and download “Fiestable” app on Google Play or App Store using your device.**
- 3 Connect the system and device via BLUETOOTH connection (page 24).**
- 4 Launch “Sony | Music Center” and touch the “Fiestable” icon.**

Note

For more details on “Sony | Music Center”, refer to the following URL.
<http://info.vssupport.sony.net/help/>

Achieving and sharing a Party People ranking and getting bonus features with Party King

The system has a unique feature that can automatically record your system usage. Based on your usage, the system will rank you with different Party People ranking according to predefined criteria. The more frequent you use the system, the higher the ranking you will achieve. Once you have achieved a certain Party People ranking, you can share your achievement through social media. The system will also award your achievements with bonus features.

Note

To use this feature, make sure “Sony | Music Center” app (page 30) and “Fiestable” app (page 31) have been installed on your device.

- 1 Connect the system and device via BLUETOOTH connection (page 25).**
- 2 Launch “Sony | Music Center” and touch the “Fiestable” icon.**
You can check your current ranking, bonus features and also find out how to achieve next ranking.

Sound Adjustment

Adjusting the sound

To	Do this
Reinforce bass sound and create more powerful sound (MEGA BASS)	Press MEGA BASS repeatedly to select "BASS ON". The MEGA BASS indicator lights up. To cancel, press MEGA BASS repeatedly to select "BASS OFF".
Reproduce the sound effect of a party hall (Fiesta)	Press SOUND FIELD repeatedly to select "FIESTA". To cancel, press SOUND FIELD repeatedly to select other sound field.
Select a sound field	Press SOUND FIELD repeatedly to select the sound field you want. To cancel, press SOUND FIELD repeatedly to select "FLAT".

Selecting the Virtual Football mode

You can experience the feeling of being in the stadium when watching a football match broadcast. Note that you can only select Virtual Football mode during AUDIO IN function.

Press **SOUND FIELD** repeatedly while watching a football match broadcast.

- "ON NARRATION": You can enjoy an immersive feeling of being in a football stadium through enhanced stadium cheers.
- "OFF NARRATION": You can enjoy a more immersive feeling of being in a football stadium by minimizing the volume level of narration in addition to the enhancement of cheers.

To cancel the Virtual Football mode

Press **SOUND FIELD** repeatedly to select "FLAT".

Note

- We recommend that you select the Virtual Football mode when watching a football match broadcast.
- If you hear unnatural sounds in the content when "OFF NARRATION" is selected, "ON NARRATION" is recommended.
- This feature does not support monaural sound.

Creating your own sound effect

You can raise or lower the levels of specific frequency bands, then store the setting in the memory as "CUSTOM EQ".

- 1 Press **OPTIONS**.
- 2 Press **↕/↕** repeatedly to select "CUSTOM EQ", then press **[+]**.
- 3 Press **↕/↕** repeatedly to adjust the equalizer level or surround setting, then press **[+]**.

4 Repeat step 3 to adjust the level of other frequency bands and surround effect.

To exit the options menu, press OPTIONS.

To select the custom equalizer setting

Press SOUND FIELD repeatedly to select "CUSTOM EQ".

Creating a party atmosphere (DJ Effect)

Use the buttons on the unit to perform this operation.

1 Press the following button to select the effect type.

- **FLANGER:** Creates a deep flanging effect that is similar to the roar of a jet plane.
- **ISOLATOR:** Isolates a specific frequency band by adjusting the other frequency bands. For example, when you want to focus on vocals.
- **SAMPLER:** Provides a series of special sound effects.

2 Change the sound effect.

For FLANGER and ISOLATOR:

Turn the VOLUME/DJ CONTROL knob to adjust the effect level.

For SAMPLER:

Press SAMPLER repeatedly to select the sampler mode you want, then press S1, S2, S3 or S4 to output the sampler sound.

To output other sampler sound continuously, turn the VOLUME/DJ CONTROL knob.

To adjust the level of the sampler sound

- 1 Press OPTIONS on the remote control.
- 2 Press \uparrow/\downarrow on the remote control repeatedly to select "SAMPLER", then press $\boxed{+}$.
- 3 Press \uparrow/\downarrow on the remote control repeatedly to adjust the sampler sound level, then press $\boxed{+}$.
To exit the options menu, press OPTIONS on the remote control.

To turn off the effect

- Press DJ OFF.
- Press the selected effect button again (for FLANGER and ISOLATOR only).

Note

- The DJ Effect is automatically turned off when you:
 - turn off the system.
 - change the function.
 - activate or deactivate the Wired Party Chain function or Wireless Party Chain function.
 - change the sound field.
 - use the Vocal Fader.
 - change the key (Key Control).
- If you activate the DJ Effect during transferring, the sound effect will not be transferred onto the USB device.
- You cannot use VOLUME/DJ CONTROL knob on the unit to adjust the volume when the DJ Effect is activated. Press VOL +/- on the remote control to adjust the volume.

Other Operations

Enjoying wired playback using multiple systems (Wired Party Chain function)

You can connect multiple audio systems in a chain to create a more interesting party environment and to produce higher sound output. An activated system in the chain will be the Party Host and share the music. Other systems will become Party Guests and play the same music as that being played by the Party Host.

Setting up the Wired Party Chain

Set up a Wired Party Chain by connecting all the systems using audio cables (not supplied).

Before connecting cables, be sure to disconnect the AC power cord (mains lead).

A If all the systems are equipped with Wired Party Chain function

Example: When connecting using this system as the first system

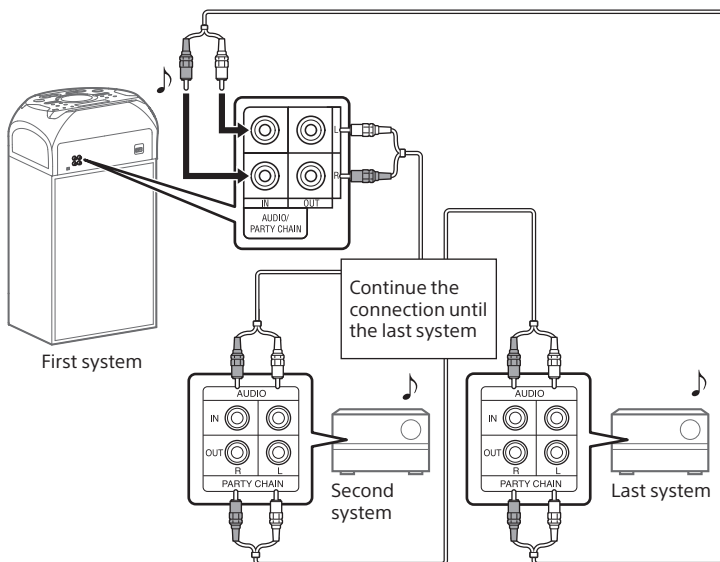

- The last system must be connected to the first system.
- Any system can become a Party Host.
- You can change the Party Host to another system in the chain. For details, see “To select a new Party Host (when all the systems are equipped with the Wired Party Chain function)” (page 36).
- Make sure that a function other than the AUDIO IN function is selected. If the AUDIO IN function is selected, this feature cannot be used.

B If one of the systems is not equipped with Wired Party Chain function

Example: When connecting using this system as the first system

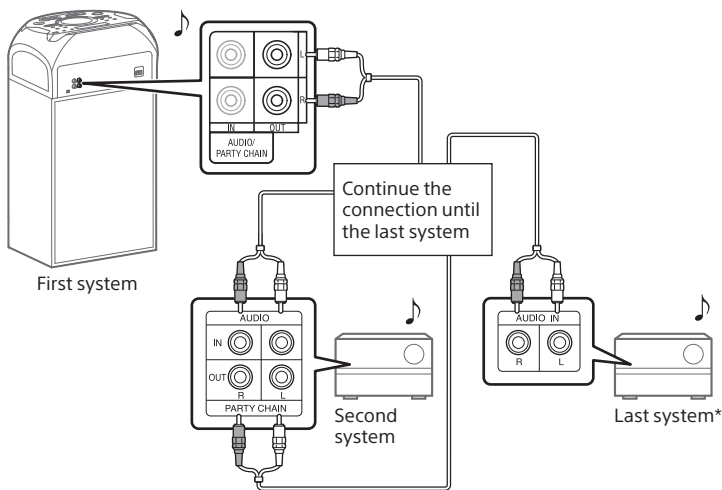

* Connect the system which is not equipped with Wired Party Chain function at the last system, otherwise the chain will stop at that system. Be sure to select the Audio In function on this last system.

- The last system is not connected to the first system.
- You must select the first system as Party Host so that all systems are playing the same music when Wired Party Chain function is activated.

Enjoying the Wired Party Chain

- 1 Plug in the AC power cord (mains lead) and turn on all the systems.**
- 2 Adjust the volume on each system.**
- 3 Activate the Wired Party Chain function on the system to be used as the Party Host.**

Example: When using this system as the Party Host

- ① Press FUNCTION repeatedly on the unit to select the function you want. If you are using connection **A** (page 34), do not select the AUDIO IN function. If you select this function, sound cannot be output.
- ② Start playing the music, then hold down **⊖ PARTY CHAIN** on the unit for 2 seconds or more. "PARTY CHAIN" appears on the display. The Party Host starts the Wired Party Chain, and other systems become Party Guests automatically. All systems play the same music as that being played by the Party Host. "WIRED P.CHAIN" lights up on the display of Party Host and Party Guests.

Note

- Depending on the total unit of systems you have connected, Party Guests may take some time to start playing the music.
- Changing the volume level and sound effect on the Party Host will not affect the output on the Party Guests.

- The Party Guest continues playing the music source as Party Host even when you change the function on Party Guest. However, you can adjust the volume and change the sound effect on Party Guest.
- When you use the microphone or play the guitar on Party Host, the sound will not be output from Party Guests.
- When one of the systems in the chain is performing USB transfer, wait for the system to complete or stop the transfer before you activate the Wired Party Chain function.
- For detailed operation on other systems, refer to the operating instructions of the systems.

To select a new Party Host (when all the systems are equipped with the Wired Party Chain function)

Repeat step 3 of "Enjoying the Wired Party Chain" on the system to be used as a new Party Host. The current Party Host becomes Party Guest automatically. All systems play the same music as that being played by the new Party Host.

Note

- You can select another system as the new Party Host only after the Wired Party Chain function of all the systems in the Chain has been activated.
- If the selected system does not become a new Party Host after a few seconds, repeat step 3 under "Enjoying the Wired Party Chain".

To deactivate the Wired Party Chain

Hold down **⊖ PARTY CHAIN** on the Party Host for 2 seconds or more. "LEAVE PARTY" appears on the display.

Note

If the Wired Party Chain function is not deactivated after a few seconds, hold down **⊖ PARTY CHAIN** on the Party Host again for 2 seconds or more.

Setting the Wired Party Chain sound mode

You can set the sound mode when the Wired Party Chain function is activated.

- 1 Press **OPTIONS**.
- 2 Press **↕/↗** repeatedly to select **"P.CHAIN MODE"**, then press **+**.
- 3 Press **↕/↗** repeatedly to select the mode you want, then press **+**.
 - **"STEREO"**: outputs the stereo sound.
 - **"RIGHT CH"**: outputs the monaural sound of the right channel.
 - **"LEFT CH"**: outputs the monaural sound of the left channel.

To exit the options menu, press **OPTIONS**.

Enjoying wireless playback using multiple systems (Wireless Party Chain function)

You can connect multiple audio systems in a chain via **BLUETOOTH** connection if all the systems are equipped with the Wireless Party Chain function. This function allows you to create a more exciting party environment and to produce higher sound output without a cable connection.

Note that you can only play back audio source from a **BLUETOOTH** device.

The first system in the chain to be activated becomes the Party Host and shares the music. Other systems become Party Guests and play the same music as that being played by the Party Host.

Setting up and enjoying the Wireless Party Chain

Example: Setting the MHC-V21 as the first system (Party Host)

- 1 Turn on all the systems.
- 2 Set the first system as the Party Host.
 - ① Press **BLUETOOTH** on the unit to select the **BLUETOOTH** function.
 - ② Connect the **BLUETOOTH** device to the system via **BLUETOOTH** connection.

- ③ Press W.PARTY CHAIN on the unit.
"CHAINING" flashes on the display. The system enters the Wireless Party Chain mode.

When the system entered Wireless Party Chain setup mode, connection to the BLUETOOTH device is terminated automatically.

3 Set the second system as a Party Guest.

- ① Press BLUETOOTH on the unit to select the BLUETOOTH function.
② Press W.PARTY CHAIN on the unit.
The second system becomes a Party Guest.
"P.CHAIN" lights up on the display.

Note

The Wireless Party Chain function is canceled in the following situations.

- There is no operation within 1 minute after the Party Host is set in step 2.
- W.PARTY CHAIN is pressed again on the Party Host before step 3 is completed.

4 Set the third or more systems as Party Guests.

Repeat step 3.

Note

Connect the third or later systems within 30 seconds of connecting the previous system. "P. CHAIN" flashes on the display of the Party Host within 30 seconds. After 30 seconds, the system cannot be connected.

5 Wait 30 seconds after the last Party Guest is connected.

"P.CHAIN" will stop flashing on the display of the Party Host and the BLUETOOTH device will reconnect to the Party Host.

6 Start playback on the connected BLUETOOTH device.

7 Adjust the volume.

When the volume on the Party Host is adjusted, the volume on Party Guests are also adjusted. If you want to adjust the volume on a particular Party Guest, adjust the volume on that Party Guest.

Note

- You cannot select another system as the new Party Host while the Wireless Party Chain is activated.
- When you use the microphone or play the guitar on Party Host, the sound will not be output from Party Guests.
- Sleep Timer and Auto Standby functions are not available on Party Guests.
- For detailed operation on other systems, refer to the operating instructions of the systems.

Hint

To add new Party Guests after Wireless Party Chain has already been established, hold down W.PARTY CHAIN on the Party Host, then repeat step 3 of "Setting up and enjoying the Wireless Party Chain" (page 37).

To deactivate the Wireless Party Chain

Press W.PARTY CHAIN on the Party Host.

Note

When you change the function or turn off the Party Host, the Wireless Party Chain will be deactivated.

To disconnect the Party Guest from the Wireless Party Chain

Press W.PARTY CHAIN on the Party Guest which want to leave. In this case, the rest of the Wireless Party Chain will remain active.

Note

When you change the function or turn off a particular Party Guest, that Party Guest will leave the Wireless Party Chain connection.

Settings synchronization during Wireless Party Chain

When the Wireless Party Chain is established, the following conditions will be applied:

- If Mega Bass and Speaker Light settings are changed on the Party Host, the settings on Party Guests are also changed.
- DJ Effect and Karaoke settings such as Vocal Fader and Key Control are turned off on both Party Host and Party Guests are turned off.
- Sound field settings return to default on both Party Host and Party Guests.
- When the Party Host is turned off, the Party Guests are also turned off.

Listening to music wirelessly with two systems (Speaker Add function)

To use this function, two same model systems are required. By connecting two systems via BLUETOOTH wireless technology, you can enjoy music in a more powerful way. You can also select an audio output between double mode (in which the two systems play the same sound) and stereo mode (stereo sound).

In the following steps, the two systems are described as “system **A**” (or Host system) and “system **B**” (or Guest system).

Note

- To use this feature, make sure “Sony | Music Center” app (page 30) has been installed to your BLUETOOTH device.
- Be sure that the BLUETOOTH device has paired with both system **A** and system **B**. For details on the pairing operation, see “Pairing this system with a BLUETOOTH device” (page 25) or “One Touch BLUETOOTH Connection by NFC” (page 27).

Setting up and enjoying the Speaker Add

- 1** Bring two systems of the same model within 1 meter (3.3 feet) of each other.
- 2** Turn on system **A** and system **B**.

3 Press **BLUETOOTH** on system **A** and system **B** to select the **BLUETOOTH** function.

"BLUETOOTH" appears on the display.

4 Connect system **A** and a **BLUETOOTH** device via **BLUETOOTH** connection (page 25).

5 Launch "Sony | Music Center" and follow the on-screen instructions to setup the **Speaker Add** for system **A** and system **B**.

"HOST" appears on the display of system **A**, and "GUEST" appears on the display of system **B**.

6 Set the output mode using "Sony | Music Center" on your **BLUETOOTH** device.

- Double Mode: outputs the stereo sound from both systems.
- Stereo mode – right: outputs the monaural sound of the right channel from system **A**, and the left channel from system **B**.
- Stereo mode – left: outputs the monaural sound of the left channel from system **A**, and the right channel from system **B**.

7 Start playback on the **BLUETOOTH** device, and adjust the volume.

For details, see "Listening to music on a **BLUETOOTH** device" (page 26).

Note

- When you use the microphone or play the guitar on system **A**, the sound will not be output from system **B**.
- The following operations are not available on system **B** when using **Speaker Add**:
 - Sleep Timer

- Auto Standby
- Child Lock
- Vocal Fader, Key Control & Scoring
- Controlling the system using remote control

Settings synchronization during **Speaker Add**

- When the **Speaker Add** connection is established, the following settings of system **B** will be synchronized with system **A**:
 - Volume
 - Mega Bass
 - Sound field and Custom EQ
 - DJ Effect
 - **Speaker Light**
- When the above settings are changed on either system **A** or system **B**, the other system settings are synchronized.
- When system **A** is turned off, system **B** also turns off.

To deactivate the **Speaker Add** function

Use "Sony | Music Center" and follow the on-screen instructions.

Note

If you want to reset one of the two systems while using the **Speaker Add** function, make sure to turn off the other system.

If you do not turn off the other system before restarting the **Speaker Add** function, **BLUETOOTH** connection or sound output may be interrupted.

Hint

- If you do not deactivate the function, the system will try to re-establish the most recent connection the next time you turn on the system.

- Switch to SBC codec when using the Speaker Add function. For details, see “Setting the BLUETOOTH audio codecs” (page 28).

Singing along: Karaoke

Preparing for Karaoke

- 1 Press MIC/GUITAR LEVEL – on the unit repeatedly to reduce the microphone volume level.**
- 2 Press GUITAR on the unit repeatedly to select “OFF”.**
- 3 Connect an optional microphone to MIC1 or MIC2/GUITAR jack on the unit.**
Connect another optional microphone if you want to sing in duet.
- 4 Start playing the music and adjust the microphone volume.**
Press MIC ECHO repeatedly to adjust the echo effect.
- 5 Start singing along with the music.**

Note

- If howling occurs:
 - move the microphone away from the system.
 - change the direction of the microphone.
 - press MIC/GUITAR LEVEL – on the unit repeatedly.
 - press MIC ECHO repeatedly to adjust the echo level.
- Microphone sound will not be transferred to the USB device during USB transfer.

- You cannot adjust the microphone volume level using the VOLUME/DJ CONTROL knob on the unit or VOL +/- button on the remote control. Press MIC/GUITAR LEVEL +/- on the unit repeatedly to adjust the microphone volume level.
- When using the Wireless Party Chain or Speaker Add function, sound from the microphone is only output from the system to which the microphone is connected.
- If the sound through the microphone is extremely loud, it may be distorted. Press MIC/GUITAR LEVEL – on the unit repeatedly to reduce the microphone volume.

Reducing the vocal sound (Vocal Fader)

You can reduce the sound of the vocal in stereo source.

Press VOCAL FADER repeatedly to select “ON V.FADER”.

Alternatively, hold down – VOCAL FADER on the unit to select “ON V.FADER”.

To cancel the Vocal Fader

Press VOCAL FADER repeatedly to select “OFF”.

Changing the key (Key Control)

Press KEY CONTROL #/b to suit your vocal range.

Activating the Karaoke scoring mode (Score Mode)

You only can use scoring function when the microphone is connected. Your score is calculated from a scale of 0 to 99 by comparing your voice with the music source.

- 1 Start playing the music.
- 2 Press **SCORE** before singing a song.
- 3 After singing for more than a minute, press **SCORE** again to view your score.

Changing your voice (Voice Changer)

You can change your voice when you talk or sing into microphone.

Press **VOICE CHANGER** on the unit repeatedly to change your voice effect.

To turn off the Voice Changer

Press **VOICE CHANGER** on the unit repeatedly to select "OFF".

Enjoying sound from a guitar

You can listen to the sound from the guitar by connecting a guitar to the **MIC2/GUITAR** jack on the unit. You can also play the guitar and sing along by connecting a microphone to the **MIC1** jack on the unit. Your guitar sound can be changed by selecting the guitar effect.

- 1 Press **MIC/GUITAR LEVEL** – on the unit repeatedly to reduce the guitar volume level.
- 2 Use an instrument cable (not supplied) to connect a guitar (not supplied) to **MIC2/GUITAR** jack on the unit.

- 3 Press **GUITAR** on the unit repeatedly to select the guitar effect.

- "CLEAN": original guitar sound. Recommended for electric guitar or electro-acoustic guitar.
- "O,DRIVE": distorted sound similar to an overdriven guitar amplifier. Recommended for electric guitar.
- "BASS": original guitar sound. Recommended for bass guitar.

- 4 Start playing the guitar and adjust the guitar volume.

The guitar sound is output from the system.

Note

- Howling may occur when using electro-acoustic guitar with "O,DRIVE" effect. Press **MIC/GUITAR LEVEL** – on the unit repeatedly to reduce the guitar volume. Otherwise, change to the other guitar effect.
- Before disconnecting the guitar from the system, press **MIC/GUITAR LEVEL** – on the unit repeatedly to reduce the guitar volume.

To turn off the guitar mode

Press **GUITAR** on the unit repeatedly to select "OFF".

Enjoying music with the Speaker Light

- 1 Press **PARTY LIGHT** repeatedly to select "LED ON".

Alternatively, press **SPEAKER LIGHT** on the unit repeatedly to select "LED ON".

2 Press LIGHT MODE repeatedly to select the illumination mode you want.

The illumination mode is different when Wireless Party Chain is activated.

To turn off the Speaker Light

Press PARTY LIGHT (or SPEAKER LIGHT on the unit) repeatedly to select "LED OFF".

Note

- Do not look directly at the light-emitting part when the Speaker Light is turned on.
- If the illumination brightness is glaring, switch on the room lights or turn off the illumination.
- You can turn on or off the Speaker Light when demonstration is turned on.

Using the Sleep Timer

The system turns off automatically after the preset time.

Press SLEEP repeatedly to select the time you want.

To cancel Sleep Timer, press SLEEP repeatedly to select "OFF".

Hint

To check the remaining time before the system turns off, press SLEEP.

Using the Voice Guidance

You can hear Voice Guidance when the system enters the BLUETOOTH pairing mode or a BLUETOOTH device is being connected or disconnected from the system.

1 Press OPTIONS.

2 Press \uparrow/\downarrow repeatedly to select "VOICE GUIDANCE", then press $\boxed{+}$.

3 Press \uparrow/\downarrow to select "ON", then press $\boxed{+}$.

The Voice Guidance is activated. To exit the options menu, press OPTIONS.

To deactivate the Voice Guidance

Select "OFF" in step 3.

To adjust the level of the Voice Guidance

1 Press OPTIONS.

2 Press \uparrow/\downarrow repeatedly to select "SAMPLER", then press $\boxed{+}$.

3 Press \uparrow/\downarrow repeatedly to adjust the Voice Guidance level, then press $\boxed{+}$.

To exit the options menu, press OPTIONS.

Note

- The Voice Guidance volume level change according to the system's volume level. However, in some cases, the Voice Guidance volume level may not change.
- In some cases, there may be a delay in Voice Guidance output or the Voice Guidance may not work.

Using optional equipment

1 Press VOL – repeatedly until "VOL MIN" appears on the display.

- 2 Connect an optional equipment (page 15).
- 3 Press FUNCTION repeatedly to select "AUDIO IN".
- 4 Start playing the connected equipment.
- 5 Press VOL + repeatedly to adjust the volume.

Note

The system may enter standby mode automatically if the volume level of the connected equipment is too low. Adjust the volume level of the equipment. To turn off automatic standby function, see "Setting the automatic standby function" (page 44).

Deactivating the buttons on the unit (Child Lock)

You can deactivate the buttons on the unit (except ) to prevent misoperation, such as child mischief.

Hold down  on the unit for more than 5 seconds.

"CHILD LOCK ON" appears on the display.

You can only operate the system using the buttons on the remote control.

To turn off the Child Lock function, hold down  on the unit for more than 5 seconds until "CHILD LOCK OFF" appears on the display.

Note

- Child Lock function will be turned off automatically when you disconnect the AC power cord (mains lead).
- Child Lock function cannot be activated when you open the disc tray.

Setting the automatic standby function

The system enters standby mode automatically in about 15 minutes when there is no operation or audio signal output.

By default, the automatic standby function is turned on.

1 Press OPTIONS.

2 Press \uparrow/\downarrow repeatedly to select "AutoSTBY", then press .

3 Press \uparrow/\downarrow repeatedly to select "ON" or "OFF", then press .

To exit the options menu, press OPTIONS.

Note

- "AutoSTBY" flashes on the display about 2 minutes before entering standby mode.
- The automatic standby function does not work in the following cases:
 - during tuner function.
 - when the Sleep Timer is activated.
 - when microphone or guitar is connected.
 - when the system is a Party Guest in the Wireless Party Chain function or the Guest system in the Speaker Add function.

Updating the software

The software of this system may be updated in the future.
You can update your system's pre-installed software from the websites below.
Follow the online instructions to update the software.

For customers in the United States:
<<https://esupport.sony.com/US/>>

For customers in Canada:
<<http://esupport.sony.com/CA/>>

Additional Information

Troubleshooting

Should you encounter a problem with your system, find your problem in the troubleshooting checklist below and take the corrective action.

If the problem persists, consult your nearest Sony dealer.

Note that if the service personnel changes some parts during repair, these parts may be retained.

If "PROTECTX" (X is a number) and "CHECK MANUAL" flashes on the display

Immediately unplug the AC power cord (mains lead), and check if anything is blocking the ventilation openings of the unit.

After you have checked and found no problems, reconnect the AC power cord (mains lead), and turn on the system. If the issue persists, contact your nearest Sony dealer.

General

The power does not turn on.

- Check that the AC power cord (mains lead) is connected securely.

The system has entered standby mode.

- This is not a malfunction. The system enters standby mode automatically in about 15 minutes when there is no operation or audio signal output (page 44).

There is no sound.

- Adjust the volume.

- Check the connection of the optional equipment, if any (page 15).
- Turn on the connected equipment.
- Unplug the AC power cord (mains lead), then plug in the AC power cord (mains lead) again and turn on the system.

There is no microphone sound.

- Adjust the microphone volume level.
- Make sure the microphone is connected to the MIC1 or MIC2/GUITAR jack on the unit correctly.
- Make sure the microphone is turned on.

There is severe hum or noise.

- Move the system away from sources of noise.
- Connect the system to a different wall outlet.
- Install a noise filter (not supplied) to the AC power cord (mains lead).
- Turn off surrounding electrical equipment.
- The noise generated by the cooling fans of the system may be heard when the system is turned on. This is not a malfunction.
- Move the unit away from the neon signs or fluorescent light.

The remote control does not function.

- Remove the obstacles between the remote control and the unit.
- Move the remote control closer to the unit.
- Point the remote control at the unit's sensor.
- Replace the batteries (R03/size AAA).
- Move the unit away from the fluorescent light.

There is acoustic feedback.

- Reduce the volume.
- Move the microphone and guitar away from the system or change the direction of the microphone.

“CHILD LOCK” appears when you press any button on the unit.

- Set the Child Lock function to off (page 44).

A clicking sound is heard when the system is turned on.

- This is the operating sound and it occurs when the system is turned on or off, for example. This is not a malfunction.

The sound loses stereo effect during playback.

- Turn off the Vocal Fader (page 41).
- Make sure the system is connected properly.

Disc player

The disc tray does not open and “LOCKED” appears on the display.

- Consult your nearest Sony dealer or local authorized Sony service facility.

The disc tray does not close.

- Load the disc correctly.

The disc does not eject.

- You cannot eject the disc during Synchronized Transfer or REC1 Transfer. Press ■ to cancel the transfer, then press ▲ on the unit to eject the disc.
- Consult your nearest Sony dealer.

Playback does not start.

- Wipe the disc clean (page 52).
- Reload the disc.
- Load the disc that this system can play back (page 8).

- Remove the disc and wipe away the moisture on the disc, then leave the system turned on for a few hours until the moisture evaporates.

The sound skips.

- Wipe the disc clean (page 52).
- Reload the disc.
- Move the unit to a place with no vibration.

Playback does not start from the first track.

- Set the play mode to Normal Play (page 19).
- Resume Play has been selected. Press ■ twice. Then, press ► to start playback.

The MP3 disc cannot be played back.

- The data is not stored in the supported format.

The folder name, track name, file name and ID3 tag characters do not appear properly.

- The ID3 version is not in Version 1 (1.0/1.1) or Version 2 (2.2/2.3).
- The character codes that can be displayed by this system are as follows:
 - Upper cases (A to Z)
 - Numbers (0 to 9)
 - Symbols (<> * +, [] \ _)
 - Other characters appear as “ _ ”.

USB device

Transferring results in an error.

- You are using an unsupported USB device. Check the information on the website about compatible USB devices (page 10).

- The USB device is not formatted correctly. Refer to the operating instructions of the USB device on how to format.
- Turn off the system and remove the USB device. If the USB device has a power switch, turn the USB device off and on again after removing it from the system. Then, perform the transfer again.
- If the transfer and erase operations are repeated multiple times, the file structure within the USB device becomes fragmented. Refer to the operating instructions of the USB device on how to deal with this problem.
- The USB device was disconnected or the power was turned off during transfer. Delete the partially-transferred file, and perform the transfer again. If this does not fix the problem, the USB device may be broken. Refer to the operating instructions of the USB device on how to deal with this problem.

Audio files or folders on the USB device cannot be erased.

- Check if the USB device is write-protected.
- The USB device was disconnected or the power was turned off during the erase operation. Delete the partially-erased file. If this does not fix the problem, the USB device may be broken. Refer to the operating instructions of the USB device on how to deal with this problem.

There is no sound.

- The USB device is not connected correctly. Turn off the system and reconnect the USB device, then turn on the system and check if “USB” appears on the display.



There is noise, skipping, or distorted sound.

- You are using an unsupported USB device. Check the information on the website about compatible USB devices (page 10).
- Turn off the system and reconnect the USB device, then turn on the system.
- The music data itself contains noise, or the sound is distorted. Noise may have entered during the transfer process. Delete the file, and try transfer again.
- The bit rate used in encoding an audio file was low. Send an audio file with higher bit rate to the USB device.

“READING” is displayed for an extended time, or it takes a long time before playback starts.

- The reading process can take a long time in the following cases.
 - There are many folders or files on the USB device (page 9).
 - The file structure is extremely complex.
 - The memory capacity is excessive.
 - The internal memory is fragmented.

“NO FILE” appears on the display.

- The system has entered the software update mode, and all buttons (except ) are deactivated. Press  on the unit to cancel the software update.

“OVER CURRENT” appears on the display.

- A problem has been detected with the level of electrical current from the  (USB) port. Turn off the system and remove the USB device from the port. Make sure there is no problem with the USB device. If this display pattern persists, contact your nearest Sony dealer.

Erroneous display.

- The data stored in the USB device may have been corrupted, perform the transfer again.
- The character codes that can be displayed by this system are as follows:
 - Upper cases (A to Z)
 - Numbers (0 to 9)
 - Symbols (< > * +, [] \ _)Other characters appear as “ _ ”.

The USB device is not recognized.

- Turn off the system and reconnect the USB device, then turn on the system.
- Check the information on the website about compatible USB devices (page 10).
- The USB device is not working properly. Refer to the operating instructions of the USB device on how to deal with this problem.

Playback does not start.

- Turn off the system and reconnect the USB device, then turn on the system.
- Check the information on the website about compatible USB devices (page 10).

Playback does not start from the first file.

- Set the play mode to Normal Play (page 19).

Files cannot be played back.

- USB devices formatted with file systems other than FAT16 or FAT32 are unsupported.*
- If you use a partitioned USB device, only files on the first partition can be played back.

* This system supports FAT16 and FAT32, but some USB devices may not support all of these FAT. For details, refer to the operating instructions of each USB device or contact the manufacturer.

Tuner*

There is severe hum or noise, or stations cannot be received.

- Connect the antenna properly.
- Change antenna location and its orientation to obtain good reception.
- Turn off nearby electrical equipment.

* Radio may not be received depending on the radio wave conditions or the housing environment in your area.

BLUETOOTH device

Pairing cannot be performed.

- Move the BLUETOOTH device closer to the system.
- Pairing may not be possible if other BLUETOOTH devices are present around the system. In this case, turn off the other BLUETOOTH devices.
- Make sure to enter the correct passkey when selecting the system's name (this system) on the BLUETOOTH device.

The BLUETOOTH device cannot detect the system, or "BT OFF" appears on the display.

- Set the BLUETOOTH signal to "BT ON" (page 29).

Connection is not possible.

- The BLUETOOTH device you attempted to connect does not support the A2DP profile, and cannot be connected with the system.
- Enable the BLUETOOTH function of the BLUETOOTH device.
- Establish a connection from the BLUETOOTH device.
- The pairing registration information has been erased. Perform the pairing operation again.

The sound skips or fluctuates, or the connection is lost.

- The system and the BLUETOOTH device are too far apart.
- If there are obstacles between the system and your BLUETOOTH device, remove or avoid the obstacles.
- If there is equipment that generates electromagnetic radiation, such as a wireless LAN, other BLUETOOTH device, or a microwave oven nearby, move them away.

The sound of your BLUETOOTH device cannot be heard on this system.

- Increase the volume on your BLUETOOTH device first, then adjust the volume using VOL +/-.

There is severe hum, noise, or distorted sound.

- If there are obstacles between the system and your BLUETOOTH device, remove or avoid the obstacles.

- If there is equipment that generates electromagnetic radiation, such as a wireless LAN, other BLUETOOTH device, or a microwave oven nearby, move them away.
- Turn down the volume of the connected BLUETOOTH device.

Wired Party Chain, Wireless Party Chain and Speaker Add

Wired Party Chain function cannot be activated.

- Check the connections (page 34).
- Make sure the audio cables are connected correctly.

“PARTY CHAIN” is flashing on the display.

- You cannot select AUDIO IN function if you make connection **A** (page 34) during Wired Party Chain function. Select other function (page 36).
- Hold down **= PARTY CHAIN** on the unit.
- Turn off the system, then turn it back on again.

Wired Party Chain function does not work properly.

- Turn off the system. Then, turn it back on again to activate the Wired Party Chain function.

BLUETOOTH device cannot be connected to the system during Wireless Party Chain function.

- After connecting all the systems, perform the pairing and connecting operations between the BLUETOOTH device and the Party Host.

BLUETOOTH device cannot be connected to the system during Speaker Add function.

- After connecting two same model systems, perform the pairing and connecting operations between the BLUETOOTH device and the Host system.

Resetting the system

If the system still does not operate properly, reset the system to factory default settings.

Use the buttons on the unit to perform this operation.

- 1 Unplug the AC power cord (mains lead), then plug it back in.
- 2 Press **⏻** to turn on the system.
- 3 Hold down **GUITAR** and **MEGA BASS** for about 3 seconds. “RESET” appears on the display. After the reset completes, the system automatically reboots. Press **⏻** to turn on the system. All BLUETOOTH pairing information and user-configured settings, such as preset radio stations are reset to factory default setting.

Messages

One of the following messages may appear or flash on the display during operation.

CANNOT PLAY

- A disc that cannot be played back was inserted.

DATA ERROR

- The file is created in unsupported format.
- The file extensions does not match the file format.

DEVICE ERROR

The USB device could not be recognized or an unknown device is connected.

DEVICE FULL

The memory of the USB device is full.

ERASE ERROR

Erase of audio files or folders on the USB device failed.

FATAL ERROR

The USB device was removed during transfer or erase operation, and may have been damaged.

FOLDER FULL

You cannot transfer onto the USB device because the number of folders has reached its maximum.

NoDEVICE

No USB device is connected or unsupported device is connected.

NO DISC

There is no disc in the unit.

NO MUSIC

No supported audio files exist in the playback source.

NO SUPPORT

An unsupported USB device is connected, or the USB device is connected through a USB hub.

NOT USE

You tried to perform a specific operation under conditions where that operation is prohibited.

OVER CURRENT

An over current from the Ψ (USB) port was detected.

PROTECT

The USB device is write-protected.

PUSH STOP

You tried to perform an operation that can be performed only when the playback is stopped.

READING

The system is reading information of the disc or USB device. Some operations are not available.

REC ERROR

The transfer did not start, stopped partway, or otherwise could not be performed.

TRACK FULL

You cannot transfer onto the USB device because the number of files has reached its maximum.

Precautions

When carrying the unit

To avoid damaging the disc mechanism, perform the following procedure before carrying the unit.

Use the buttons on the unit to perform this operation.

- 1 Press ⏻ to turn on the system.
- 2 Press FUNCTION repeatedly to select "CD".
- 3 Remove the disc.
Press \blacktriangle to open and close the disc tray.
Wait until "NO DISC" appears on the display.
- 4 Press ⏻ to turn off the system.
- 5 Unplug the AC power cord (mains lead).

Notes on discs

- Before playing, wipe the disc with a cleaning cloth from the center outward to the edge.
- Do not clean discs with solvents, such as benzene, thinner, or commercially available cleaners or anti-static spray intended for vinyl LPs.
- Do not expose discs to direct sunlight or heat sources such as hot air ducts, nor leave them in a car parked in direct sunlight.

On safety

- Completely disconnect the AC power cord (mains lead) from the wall outlet (mains) if it is not going to be used for an extended period of time. When unplugging the system, always grip the plug. Never pull the cord itself.
- Should any solid object or liquid get into the system, unplug the system, and have it checked by qualified personnel before operating it again.
- AC power cord (mains lead) must be changed only at the qualified service shop.

On handling the system

This system is not drip-proof or waterproof. Make sure not to splash water on the system or clean it with water.

On placement

- Do not place the system in an inclined position or in locations that are extremely hot, cold, dusty, dirty, or humid or lacking adequate ventilation, or subject to vibration, direct sunlight or a bright light.
- Be careful when placing the system on surfaces that have been specially treated (for example, wax, oil, polish) as staining or discoloration of the surface may result.

- If the system is brought directly from a cold to a warm location or is placed in a very damp room, moisture may condense on the lens inside the unit, and cause the system to malfunction. In this situation, remove the disc, and leave the system turned on for about an hour until the moisture evaporates.

On heat buildup

- Heat buildup on the unit during operation is normal and is not a cause for alarm.
- Do not touch the cabinet if it has been used continuously at a high volume because the cabinet may have become hot.
- Do not obstruct the ventilation holes.

On the speaker system

The built-in speaker system is not magnetically shielded, and the picture on nearby TV sets may become magnetically distorted. In this situation, turn off the TV, wait 15 to 30 minutes, and turn it back on. If there is no improvement, move the system far away from the TV.

Cleaning the cabinet

Clean this system with a soft cloth slightly moistened with a mild detergent solution. Do not use any type of abrasive pad, scouring powder, or solvent, such as thinner, benzene, or alcohol.

On BLUETOOTH communication

- BLUETOOTH devices should be used within approximately 10 meters (33 feet) (unobstructed distance) of each other. The effective communication range may become shorter under the following conditions.
 - When a person, metal object, wall or other obstruction is between the devices with a BLUETOOTH connection
 - Locations where a wireless LAN is installed
 - Around microwave ovens that are in use
 - Locations where other electromagnetic waves are generated

- BLUETOOTH devices and wireless LAN (IEEE 802.11b/g/n) equipment use the same frequency band (2.4 GHz). When using your BLUETOOTH device near a device with wireless LAN capability, electromagnetic interference may occur. This could result in lower data transfer rates, noise, or inability to connect. If this happens, try the following remedies:
 - Use this system at least 10 meters (33 feet) away from the wireless LAN equipment.
 - Turn off the power of the wireless LAN equipment when using your BLUETOOTH device within 10 meters (33 feet).
 - Use this system and BLUETOOTH device as close to each other as possible.
- The radio waves broadcast by this system may interfere with the operation of some medical devices. Since this interference may result in malfunction, always turn off the power on this system and BLUETOOTH device in the following locations:
 - In hospitals, on trains, in airplanes, at gas stations, and any place where flammable gases may be present
 - Near automatic doors or fire alarms
- This system supports security functions that comply with BLUETOOTH specifications to ensure secure connections during communication using BLUETOOTH technology. However, this security may be insufficient depending on the setting contents and other factors, so always be careful when performing communication using BLUETOOTH technology.
- Sony cannot be held liable in any way for damages or other loss resulting from information leaks during communication using BLUETOOTH technology.
- BLUETOOTH communication is not necessarily guaranteed with all BLUETOOTH devices that have the same profile as this system.
- BLUETOOTH devices connected with this system must comply with the BLUETOOTH specification prescribed by the Bluetooth SIG, Inc., and must be certified to comply. However, even when a device complies with the BLUETOOTH specification, there may be cases where the characteristics or specifications of the BLUETOOTH device make it impossible to connect, or may result in different control methods, display or operation.
- Noise may occur or the audio may cut off depending on the BLUETOOTH device connected with this system, the communications environment, or surrounding conditions.

Specifications

AUDIO POWER SPECIFICATIONS

POWER OUTPUT AND TOTAL HARMONIC DISTORTION: (USA models only)

With 3 ohm loads, both channels driven, from 800 Hz – 20,000 Hz; rated 30 watts per channel minimum RMS power at stereo mode, with no more than 0.7% total harmonic distortion from 250 milliwatts to rated output.

Speaker section

Speaker system:

2-way, Bass Reflex

Speaker unit:

Tweeter L/R: 66 mm (2 5/8 in), cone type

Woofer: 200 mm (8 in), cone type

Inputs

AUDIO/PARTY CHAIN IN L/R:

Voltage 2 V, impedance 47 kilohms

MIC1:

Sensitivity 1 mV, impedance
10 kilohms

MIC2/GUITAR:

Sensitivity 1 mV, impedance
10 kilohms (When guitar mode is
turned off.)
Sensitivity 200 mV, impedance
250 kilohms (When guitar mode is
turned on.)

Outputs

AUDIO/PARTY CHAIN OUT L/R:

Voltage 2 V, impedance 1 kilohm

Disc player section

System:

Compact disc and digital audio
system

Laser Diode Properties

Emission Duration: Continuous
Laser Output*: Less than 44.6 μ W
* This output is the value
measurement at a distance of
200 mm from the objective lens
surface on the Optical Pick-up
Block with 7 mm aperture.

Frequency response:

20 Hz – 20 kHz

USB section

Supported USB device:

Mass Storage Class

Maximum current:

1 A

ψ (USB) port:

Type A

FM tuner section

FM stereo, FM superheterodyne tuner

Antenna:

FM lead antenna

Tuning range:

87.5 MHz – 108.0 MHz (100 kHz
step)

BLUETOOTH section

Communication system:

BLUETOOTH Standard version 4.2

Output:

BLUETOOTH Standard Power
Class 2

Maximum number of devices to be
registered:

8 devices

Maximum number of simultaneous
connection (Multipoint):

3 devices

Maximum communication range:

Line of sight approx. 10 m (33 ft)¹⁾

Frequency band:

2.4 GHz band (2.4000 GHz –
2.4835 GHz)

Modulation method:

FHSS (Freq Hopping Spread
Spectrum)

Compatible BLUETOOTH profiles²⁾:

A2DP (Advanced Audio
Distribution Profile)
AVRCP (Audio Video Remote
Control Profile)
SPP (Serial Port Profile)

Supported codecs:

SBC (Subband Codec)
AAC (Advanced Audio Coding)
LDAC

¹⁾ The actual range will vary depending on factors such as obstacles between devices, magnetic fields around a microwave oven, static electricity, reception sensitivity, antenna's performance, operating system, software application, etc.

²⁾ BLUETOOTH standard profiles indicate the purpose of BLUETOOTH communication between devices.

Supported audio formats

Supported bit rate and sampling frequencies:

MP3:

32/44.1/48 kHz, 32 kbps –
320 kbps (VBR)

AAC:

44.1 kHz, 48 kbps – 320 kbps
(CBR/VBR)

WMA:

44.1 kHz, 48 kbps – 192 kbps
(CBR/VBR)

WAV:

44.1/48 kHz (16 bit)

General

Power requirements:

AC 120 V, 60 Hz

Power consumption:

70 W

Dimensions (W/H/D) (Approx.):

324 mm × 600 mm × 286 mm
(12 7/8 in × 23 3/4 in × 11 3/8 in)

Mass (Approx.):

8.4 kg (18 lb)

Operating temperature:

5 °C to 35 °C (41 °F to 95 °F)

Design and specifications are subject to change without notice.

<http://www.sony.net/>



MP3



* 4 7 3 6 6 0 7 1 2 * (1)