

# ***Home Theater Active Speaker System***

---

Operating Instructions

**SA-VA10**

## WARNING

To prevent fire or shock hazard, do not expose the unit to rain or moisture.

## NOTICE FOR THE CUSTOMERS IN THE U.S.A.

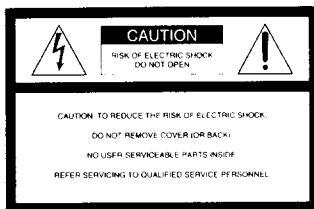

This symbol is intended to alert the user to the presence of uninsulated “dangerous voltage” within the product’s enclosure that may be of sufficient magnitude to constitute a risk of electric shock to persons.



This symbol is intended to alert the user to the presence of important operating and maintenance (servicing) instructions in the literature accompanying the appliance.

### Owner’s Record

The model and serial numbers are located on the rear panel. Record the serial number in the space provided below. Refer to them whenever you call upon your Sony dealer regarding this product.  
Model No. SA-VA10  
Serial No. \_\_\_\_\_

## INFORMATION

This equipment has been tested and found to comply with the limits for a Class B digital device, pursuant to Part 15 of the FCC Rules. These limits are designed to provide reasonable protection against harmful interference in a residential installation. This equipment generates, uses, and can radiate radio frequency energy and, if not installed and used in accordance with the instructions, may cause harmful interference to radio communications. However, there is no guarantee that interference will not occur in a particular installation. If this equipment does cause harmful interference to radio or television reception, which can be determined by turning the equipment off and on, the user is encouraged to try to correct the interference by one or more of the following measures:

- Reorient or relocate the receiving antenna.
- Increase the separation between the equipment and receiver.
- Connect the equipment into an outlet on a circuit different from that to which the receiver is connected.
- Consult the dealer or an experienced radio/TV technician for help.

### CAUTION

You are cautioned that any changes or modifications not expressly approved in this manual could void your authority to operate this equipment.

## NOTICE FOR THE CUSTOMERS IN CANADA

### CAUTION:

TO PREVENT ELECTRIC SHOCK, DO NOT USE THIS POLARIZED AC PLUG WITH AN EXTENSION CORD, RECEPTACLE OR OTHER OUTLET UNLESS THE BLADES CAN BE FULLY INSERTED TO PREVENT BLADE EXPOSURE.

## Welcome!

Thank you for purchasing a Sony speaker system. Before operating the unit, please read this manual thoroughly and retain it for future reference.

## About This Manual

The instructions in this manual describe the controls on the left speaker. You can also use the controls on the remote if they have the same or similar names as those on the left speaker.

- The following icons are used in this manual:



Indicates that you can use only the remote to do the task.



Indicates hints and tips for making the task easier.

This speaker system incorporates the Dolby Pro Logic Surround System.\*

\* Manufactured under license from Dolby Laboratories Licensing Corporation. DOLBY, the double-D symbol  and “PRO LOGIC” are trademarks of Dolby Laboratories Licensing Corporation.

# TABLE OF CONTENTS

---

## Overview 4

---

## Getting Started

- Precautions 6
  - Unpacking 6
  - Installing the Anti-vibration pads 7
  - Choosing the Best Location 7
  - Speaker System Hookups 8
  - Audio Component Hookups 9
- 

## Home Theater Operations

- Enjoying Surround Sound 10
  - Adjusting the Surround Sound 11
  - Adjusting the Sound 12
  - Using an External Center Speaker 13
- 

## Additional Information

- Troubleshooting 14
- Specifications 14
- Glossary 15
- Index 15

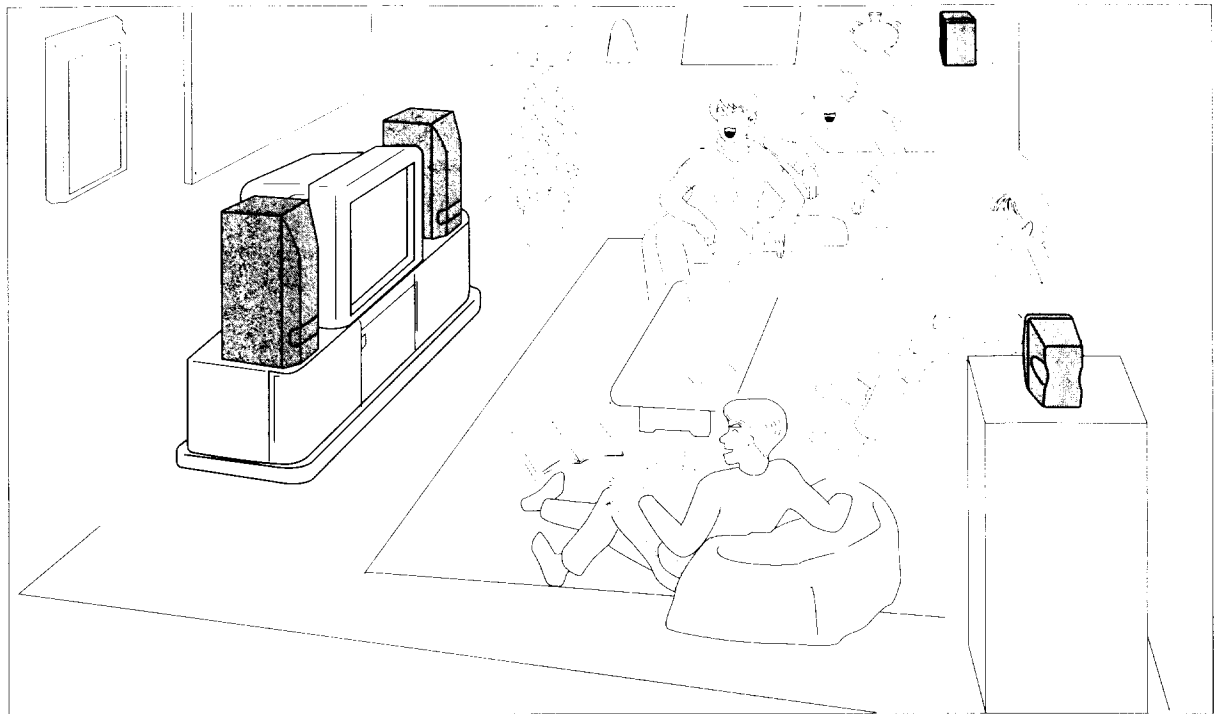

The SA-VA10 is an active home-theater speaker system incorporating a Dolby Pro Logic decoder and super woofer speakers. Its design features allow easy connection to your current TV/VCR setup. You can connect this system without having to reconnect the cords of your TV and VCR. Also, you don't have to connect a center speaker to optimize the surround effects. Easy operation via the supplied remote ensures maximum enjoyment of the home-theater sound this system provides.

### Three different types of surround sound accommodate a variety of program sources

#### **Dolby Surround (Pro Logic) mode**

Lets you enjoy superb theater-like presence and surround effects in your home when playing back video software encoded with the Dolby Surround system.

#### **HALL surround mode**

Reproduce the acoustics of a rectangular concert hall. Ideal for soft, acoustic sounds, or giving an extra punch to debates and press conferences.

#### **GAME surround mode**

Obtain maximum audio impact from video game software.

#### **Optionally available speaker stand**

For some models, optional speaker stand WS-V10 is available.

## Dolby Pro Logic Surround sound

The use of a center speaker is a key factor in obtaining a full surround effect when playing sources encoded with the Dolby Pro Logic Surround sound system. Center speakers in a movie theater make central sounds, such as dialogue, clearer and create a unified sound image.

Normally, you have to install a center speaker separately, but this speaker system makes it easy to set up a high-performance home theater system by incorporating a high-quality center speaker system into the front speakers.

Top view

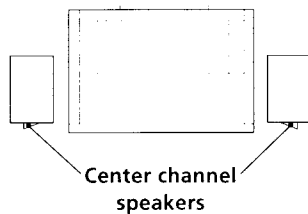

Front view

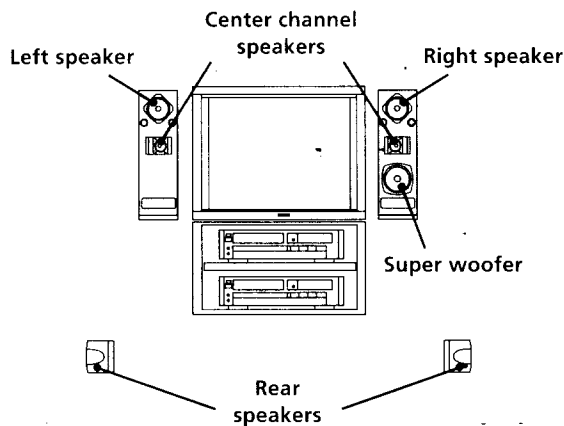

### How the center speaker works

The front left and right speakers are equipped with center channel tweeters (see above) angled inwards at 30° to reproduce high-frequency center channel sounds. Low-frequency center channel sounds are mixed with the front channel signals and reproduced through the front left and right full range units. This design produces a high-quality centralized sound image for the center channel which exactly matches the quality of the front channel sound to provide superior sound quality and a unified sound image without a cumbersome external center speaker.

## Dynamic Bass Roar (DBR) super woofer system provides theater-like bass sound

To provide a theater-like experience complete with dynamic bass sounds, this speaker system incorporates the Super Acoustically-loaded Woofer (SAW) design (see below) in the right front speaker to form a DBR super woofer system.

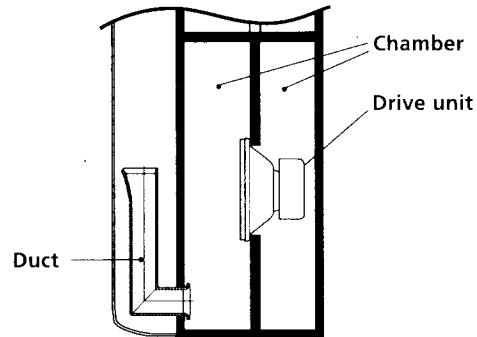

### What is the SAW design?

The SAW design features a centrally-positioned woofer drive unit, two chamber construction, and a long duct. Through precision control of the acoustics of the two chambers, the unit can reproduce powerful ultra low frequencies without muddiness.

In addition, we also included two super woofer modes designed to bring the dynamic bass sounds found in movie theaters (mode 1) and concert halls (mode 2) to your living room.

### Power turns on and off automatically

The speakers will turn on automatically when a sound signal is input and turn off when you've finished watching a program and the sound signal goes out. So you don't have to bother using the power switch every time you use the system.

## Precautions

### On safety

- Should any solid object or liquid fall into the cabinet, unplug the speaker system and have it checked by qualified personnel before operating it any further.

### On power sources

- Before operating the speakers, check that the operating voltage is identical with your local power supply. The operating voltage is indicated on the nameplate on the rear of the speakers.
- The speakers are not disconnected from the AC power source as long as they are connected to the wall outlet, even if the speakers themselves have been turned off.
- If you are not going to use the speakers for a long time, be sure to disconnect the speakers from the wall outlet. To disconnect the AC power cord, grasp the plug itself; never pull the cord.
- One blade of the plug is wider than the other for the purpose of safety and will fit into the wall outlet only one way. If you are unable to insert the plug fully into the outlet, contact your dealer.
- AC power cord must be changed only at the qualified service shop.

### On placement

- Do not place the speakers near heat sources, or in a place subject to direct sunlight, excessive dust or mechanical shock.
- Good ventilation is essential to prevent internal heat buildup. Place the speakers in a location with adequate air circulation, and in a way that does not block the rear ventilation holes.

### On cleaning

- Clean the cabinet, panel and controls with a soft cloth slightly moistened with a mild detergent solution. Do not use any type of abrasive pad, scouring powder or solvent such as alcohol or benzine.

If you have any question or problem concerning your receiver, please consult your nearest Sony dealer.

## Unpacking

Check that you received the following items with your speaker system:

- Front L/R speaker connecting cord, 3.5 m (1)
- Rear speaker SS-SR151 (2)
- Rear speaker connecting cord, 10 m (2)
- Audio connecting cord, 1.5 m (1)
- Remote commander (remote) RM-J10 (1)
- Sony SUM-3 (NS) batteries (2)
- Anti-vibration pads (8)

## Inserting batteries into the remote

Insert two size AA (R6) batteries with the + and – on the battery compartment. When using the remote, point it at the remote sensor  on the left front speaker.

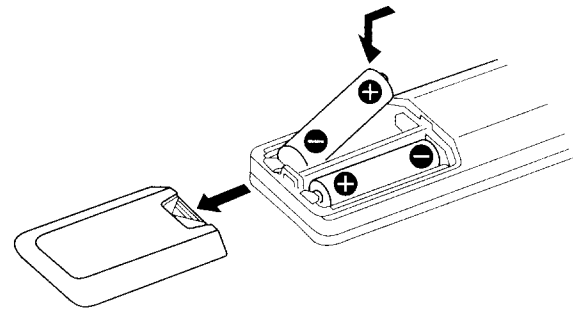

### When to replace batteries

Under normal use, the batteries should last for about 6 months. When the remote no longer operates the speakers, replace both batteries with new ones.

### Notes

- Do not leave the remote in an extremely hot or humid place.
- Do not use a new battery with an old one.
- Do not expose the remote sensor to direct sunlight or lighting apparatuses. Doing so may cause a malfunction.
- If you don't use the remote for an extended period of time, remove the batteries to avoid possible damage from battery leakage and corrosion.

## Using the remote

You can use the shaded buttons shown below to operate Sony TVs.

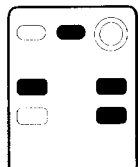

To	Press
turn on a Sony TV	TV POWER
operate a Sony TV	the button(s) for the operation you desire.
turn off a Sony TV	TV POWER

## Installing the Anti-vibration pads

- 1 Spread a towel, or other soft cloth, over a table and lay the speakers down.
- 2 Peel off the covering sheet from the anti-vibration pad and attach it on the bottom of the speakers (4 for each speaker).

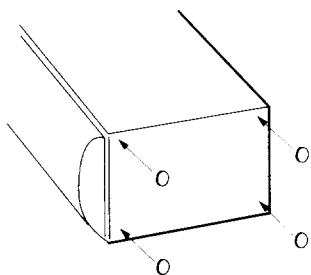

- 3 Make sure the anti-vibration pads are securely attached and stand the speaker upright.

## Choosing the Best Location

To obtain high sound quality and a proper sound image from the front speakers, place the speaker with the built-in operation panel to the left of your TV and the other to the right of your TV so that the center channel tweeters angle towards the center of the room.

For the best central sound image, place the left and right speakers within 5 feet of each other and equidistant from the TV.

The left and right speakers must be placed standing upright, laying them on their sides will defeat the center channel surround effect.

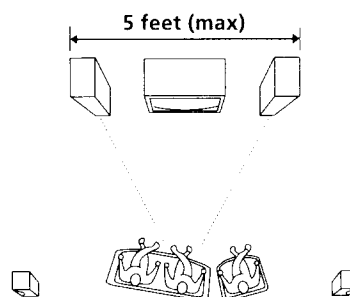

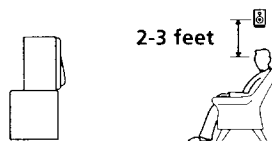

Place the rear speakers so that they fire directly across at each other about 2 to 3 feet above your listening position.

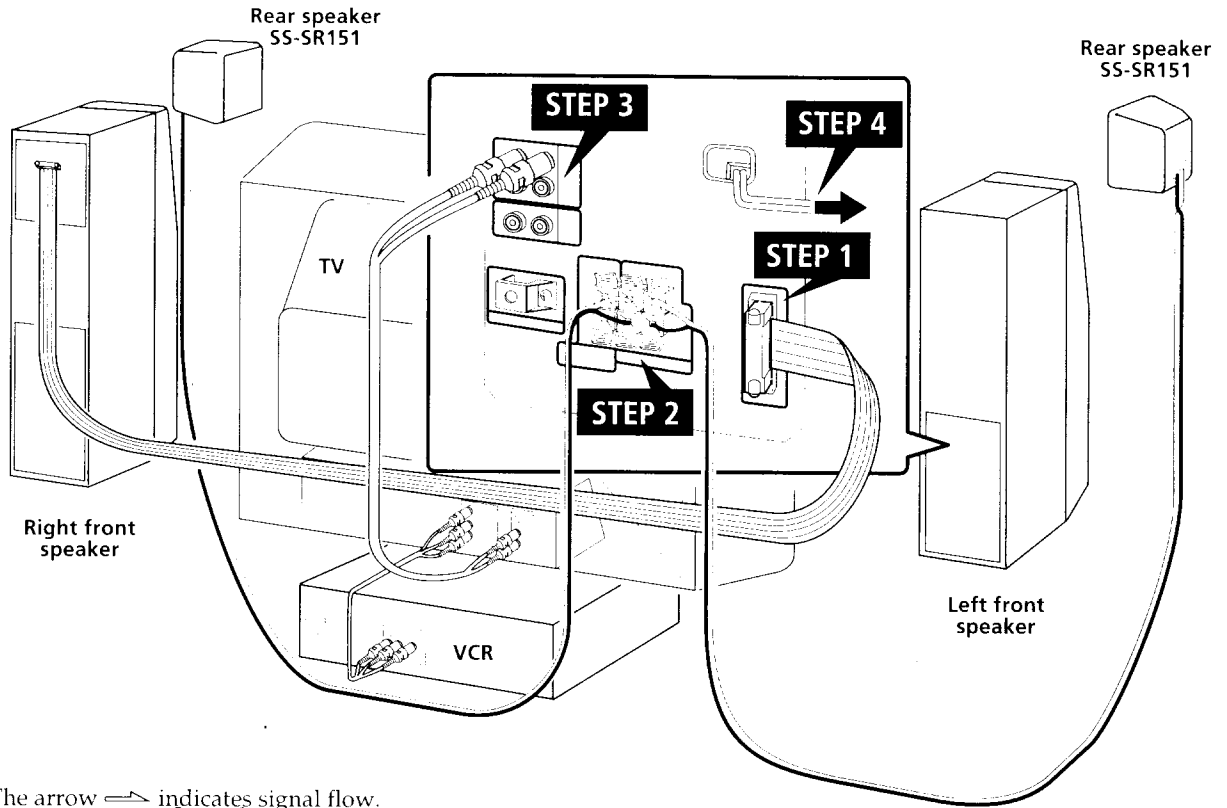

## Speaker System Hookups

This section describes how to connect the speaker system and how to connect your TV or VCR to the speakers.



The arrow  indicates signal flow.

### STEP 1 Connecting the front speakers

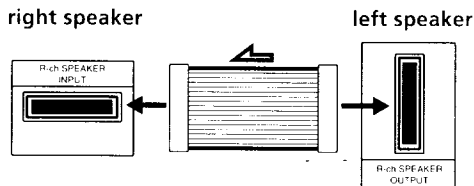

To connect, depress the middle of the male connector until it clicks into the female connector.

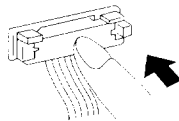

To disconnect, pull the connector out. Never pull the cord itself.

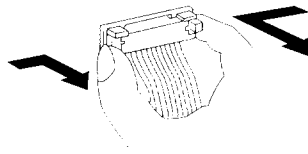

- 1 Twist the speaker cord coating and strip it from the end of the cords.

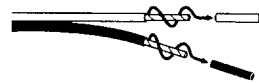

- 2 Insert the stripped wire into speaker terminals.

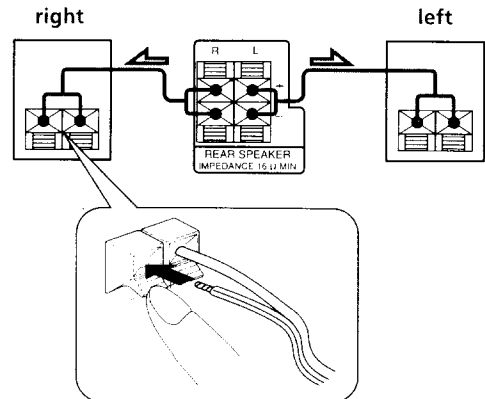

### STEP 2 Connecting the rear speakers

Use the supplied speaker cord to connect the left and right rear speakers.

Be sure to connect matching speaker terminals (e.g. use the striped wire to connect + to +, and use the solid wire to connect - to -). If the connections are reversed (+ to -), the sound will be distorted and lack bass.

### STEP 3 Connecting your TV

If the audio and video output terminals on your TV and VCR are already connected, and your TV has stereo AUDIO OUT jacks, you can start enjoying surround sound simply by connecting the speaker system to your TV as shown below.

#### Important

- Set the volume on your TV to MIN (minimum).
- If your TV has an ON/OFF switch for its internal speaker, set it to OFF and enjoy the sound from this speaker system.

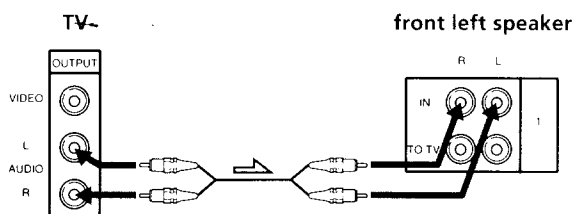

#### If you use AUDIO OUT jacks marked VARIABLE

After making the connection as shown above, turn up the volume on the TV. Use this speaker system's volume control for regular volume adjustment. Turning down the volume on the TV reduces the AUDIO OUT signal level and may cause a loss in sound quality and/or the auto-power off function (see page 11) to function.

#### For the best possible sound (or if your TV only has a monaural AUDIO OUT jack, or no AUDIO-OUT jacks)

Connect the speaker system directly to your VCR or cable box.

The following connections suppress noise from the TV and let you enjoy high quality sound.

- 1 Connect your VCR or cable box to the 1 IN jacks on the left front speaker.
- 2 Connect your TV to the TO TV jacks on the left front speaker.

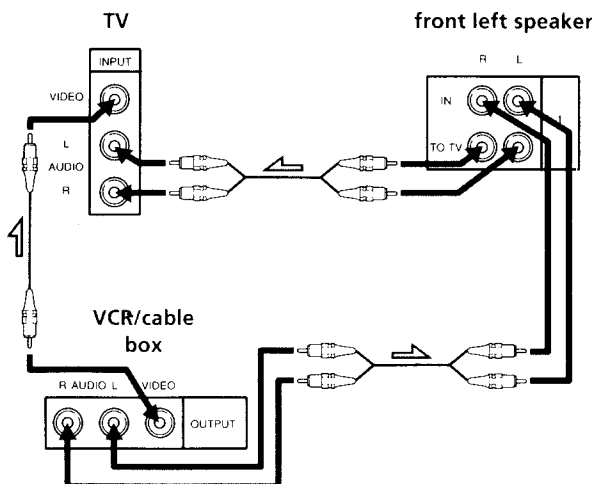

### STEP 4 Connecting the AC power cord

Connect the AC power cord to a wall outlet.

## Audio Component Hookups

Since this speaker system incorporates its own internal amplifier and preamplifier, you can also connect an audio component, such as a CD player.

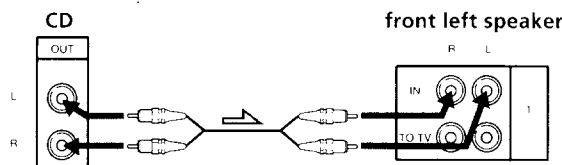

#### Note

Do not connect an amplified audio source. The combined amplification from the component and the speaker's internal amplifier may damage the speakers.

#### Hooking up the Sony HCD-VA550 (Optional Compact Disc Deck Receiver)

- 1 Connect the LINE OUT FIXED jacks on the HCD-VA550 to the 2 IN jacks on the left front speaker. Be sure to connect it to the 2 IN jacks.

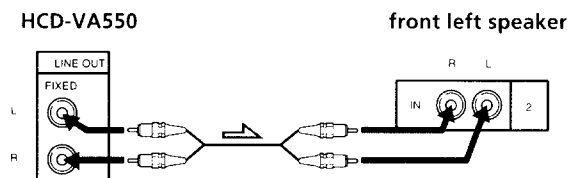

## Enjoying Surround Sound

You can take advantage of the speaker's surround sound simply by choosing a surround mode according to the type of program you are watching. This system is provided with three different surround modes:

### DOLBY SUR. (Dolby Pro Logic Surround)

Reproduces superb theater-like presence and surround effects from video software encoded with Dolby Surround.

### HALL surround mode

Reproduce the acoustics of a rectangular concert hall. Ideal for soft, acoustic sounds, or for giving an extra punch to debates and press conferences.

### GAME surround mode

Obtain maximum audio impact from video game software.

### Remote

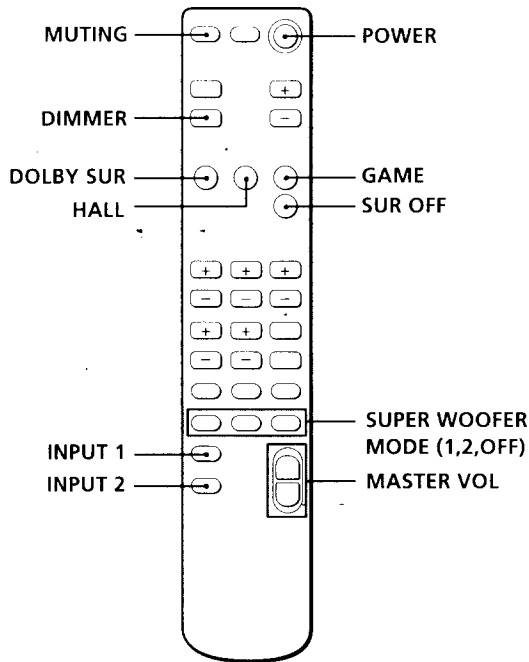

### Left speaker

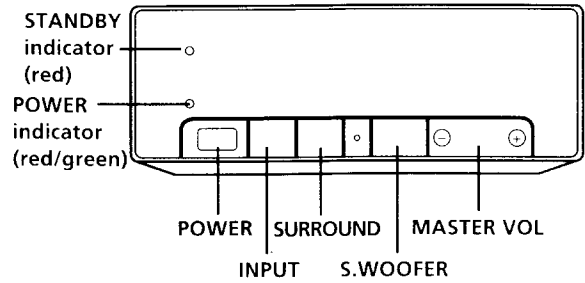

- 1 Press POWER. The POWER indicator lights (green) and the speakers turn on. Once you've turned the speakers on, they turn themselves off and on automatically with the auto power on/off function.
- 2 Press INPUT 1 or 2 on the remote or INPUT on the operation panel to select the program source. For example, if you connected your VCR to the 1 IN jacks, select INPUT 1. The respective INPUT indicator lights up.
- 3 Start playback from the program source.
- 4 Press either DOLBY SUR, HALL or GAME on the remote, or SURROUND on the operation panel a few times, according to the program you want to enjoy.

program	DOLBY SUR	HALL	GAME	SUR OFF
recent movies	●			
concerts	●	●		
music		●		
sports		●		
video game			●	
education, news				●

### To listen without surround effects

Press SUR OFF on the remote, or press SURROUND on the operation panel a few times until SUR OFF is displayed.

### Note

Some videos and laser discs may use Dolby Surround sound even if it's not indicated on the package.

- 5 Press MASTER VOL. (VOLUME) to adjust the volume.

**To select a suitable SUPER WOOFER mode**

Press SUPER WOOFER MODE 1 or 2. SUPER WOOFER MODE 1 provides powerful bass sound ideal for movies. SUPER WOOFER MODE 2 is a more subtle effect designed for music.

**To mute the sound**

Press MUTING. To restore the sound, press MUTING again.

For other sound adjustments, see page 13.

**The speakers turn on and off automatically (Auto power on/off function)**

Three minutes after the sound signal goes out (when you turn off the TV, or the currently playing video/laserdisc ends), the speakers turn off automatically and the POWER indicator turns red. The speakers turn themselves back on the next time you turn on the TV or start playback from the VCR and the POWER indicator turns green.

**If you press POWER on the remote when the speakers are on**

The speakers enter standby mode (the red standby indicator lights up) and the auto power on/off function will not operate. You have to press POWER on the remote again to turn on the speakers.

**Changing the display**

You can dim the display, or turn it off, according to your preference.

Press DIMMER, on the remote, a few times until the display mode you desire appears. The display returns to full brightness temporarily when you press one of the buttons on the control panel or the remote.

**Adjusting the Surround Sound**

Although this speaker system is factory preset to provide balanced surround sound without adjustment, you can adjust the volume of each speaker and the delay time to accommodate the conditions in your living room or your individual preference.

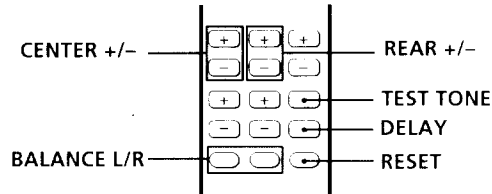

**Adjusting the speaker volumes**

The test tone feature lets you adjust the volume of the sound coming from each speaker to the same level, so that the surround sound will be even and natural.

Make the following adjustments from your listening position.

- 1 Choose the DOLBY SUR mode.
- 2 Press TEST TONE on the remote. The test tone comes from each speaker in sequence:

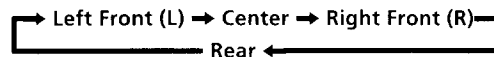

- 3 Adjust the volume levels so that you hear the test tone from each speaker at the same volume level when you are in your listening position:

To adjust the level	press
between the right and left front speakers	BALANCE L or R
of the center speaker	CENTER + or -
of the rear speaker	REAR + or -

- 4 Press TEST TONE on the remote to turn off the test tone.

**To restore the center, rear, or balance levels to the factory setting**

Press CENTER +/-, REAR +/-, or BALANCE L/R, then press RESET.

(continued)

**Note**

Pressing buttons other than MASTER VOL., RESET, CENTER +/-, REAR +/-, or BALANCE L/R cancels the test tone.

## Adjusting the delay time

By adjusting the delay time you can enhance the spatial characteristics of the sound to obtain a theater-like presence regardless of the size of your room. If the rear speakers are close to your listening position, choose a longer delay time.

You can adjust the settings individually for DOLBY SUR, HALL and GAME.

**Note**

The delay time cannot be adjusted in PRO LOGIC 3CH mode.

- 1 Choose any surround mode.
- 2 Playback a program.
- 3 Press DELAY on the remote once to display the current delay time.
- 4 Press DELAY a few times to choose the delay time you prefer, either 15, 20, or 30 ms.  
The factory setting is 20 ms.

### To restore the delay time to the factory setting

Press DELAY and then RESET.

## Resetting an entire surround mode

Press the button for the surround mode you want to reset (i.e., HALL) and then press RESET while the name of the surround mode is being displayed. All of the adjustments in that mode, including the bass and treble, are reset to the factory settings.

## Adjusting the Sound

Although this speaker system's sound quality is already adjusted. You can change the settings, as you like, for each surround mode individually. The following settings remain stored in their respective surround mode until you change them.

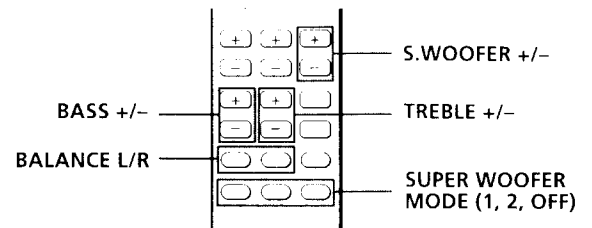

- 1 Playback a program and choose a surround mode.
- 2 Make the following sound adjustments according to your preference and/or the type of program you are watching.

To	press
adjust the super woofer level	S.WOOFER + or -
adjust the bass level	BASS + or -
adjust the treble level	TREBLE + or -
adjust the balance	BALANCE L or R*

\* Since BALANCE L and R control sound from the front speakers, they have little effect on DOLBY SUR when the source software has a high proportion of center-channel sound.

### To restore the factory settings

Press RESET after pressing either S.WOOFER +/-, BASS +/-, TREBLE +/-, or BALANCE L/R.

## Using an External Center Speaker

Since this system incorporates a center speaker (see page 5), you don't have to connect a center speaker. However, it is possible to connect a center speaker, if you already have one, to the CENTER SPEAKER terminals. Be sure to use a speaker with a 8 to 16 ohm impedance for the center speaker.

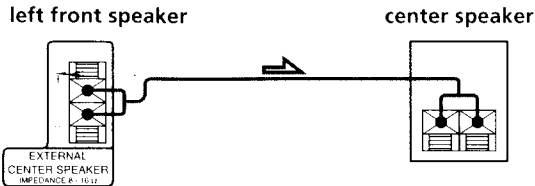

Use a screwdriver and remove the screw holding the CENTER SPEAKER button cover in place. Then depress the CENTER SPEAKER button. This turns off the internal center speaker and directs the center channel signal to the CENTER SPEAKER terminals.

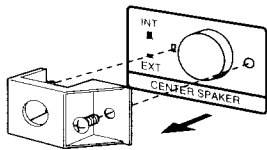

Connecting an external center speaker lets you choose from 4 different Dolby Pro Logic Surround center modes: NORMAL, WIDE, 3 CH (3 Channel logic), or PHANTOM. Use the NORMAL or WIDE mode. For details on Dolby Pro Logic Surround sound, see page 15.

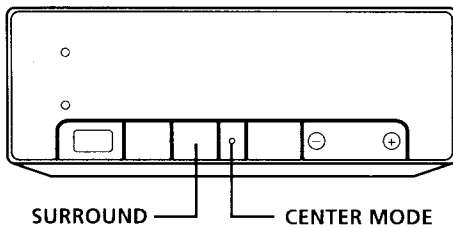

- 1** Press SURROUND on the front left speaker to choose PRO LOGIC. ("PRO LOGIC" appears in the display instead of "DOLBY SUR" when you connect an external center speaker.)
- 2** Press CENTER MODE on the front left speaker a few times until the center mode you want appears in the display.

- 3** Adjust the speaker volumes and delay time, if necessary, by referring to pages 11 and 12.

## Troubleshooting

If you experience any of the following difficulties while using the speakers, use this troubleshooting guide to help you remedy the problem. Should any problem persist, consult your nearest Sony dealer.

### There's no sound from any of the speakers.

- ➔ Check that components are connected securely to the speakers.
- ➔ Make sure you selected the correct input (1 or 2).
- ➔ Press **MUTING** to cancel the muting function.
- ➔ Press **MASTER VOLUME +** to turn up the volume.
- ➔ Turn up the volume on the TV to increase the output level when using the TV's **VARIABLE AUDIO OUTPUT** terminals.

### No sound or only a very low sound level is heard from the rear speakers.

- ➔ Surround sound is turned off.
- ➔ Adjust the volume of the rear speakers (see page 11).
- ➔ Check the sound image balance with **TEST TONE** (see page 11).

### There's no sound from the center speaker.

- ➔ Make sure you selected the **DOLBY SUR** (or **PRO LOGIC**) surround mode.
- ➔ No center speaker is connected, but the **CENTER SPEAKER** button on the rear panel is set to **EXTERNAL**.
- ➔ You connected an external center speaker, but the **Dolby Pro Logic Surround center mode** is set to **PHANTOM**.
- ➔ You connected an external center speaker, but the **CENTER SPEAKER** button

on the rear panel is set to **INTERNAL**.

### Severe hum or noise is heard.

- ➔ Move the connecting cord away from any transformers or motors and least 3 meters (10 feet) from any fluorescent lights.
- ➔ Connect the speakers to your **VCR** or **cable box** instead of to your **TV** (see page 9).

### Remote operations cannot be performed.

- ➔ Point the remote towards the remote sensor on the left front speaker.
- ➔ Remove any obstructions between the remote and this system's left front speaker.
- ➔ Replace the batteries in the remote.

### Picture on TV screen vibrates or distorts.

- ➔ Move the speakers farther away from the TV.

## Specifications

### AUDIO POWER SPECIFICATIONS

#### POWER OUTPUT AND TOTAL HARMONIC DISTORTION:

For center and front full range speakers: With 8 ohm loads, both channels driven, from 70 Hz – 20 kHz; rated 15 watts per channel minimum RMS power, with no more than 0.9 % total harmonic distortion from 250 milliwatts to rated output.

#### Amplifier section

<b>Continuous RMS power output</b>	total 100 W
<b>Center tweeter</b>	20 W (8 ohms at 10 kHz, 9 % THD)
<b>Front full range/Center woofer</b>	20 W + 20 W (8 ohms at 1 kHz, 9 % THD)
<b>Super woofer</b>	20 W (8 ohms at 40 Hz, 9 % THD)
<b>Rear</b>	20 W (8 ohms at 1 kHz, 9 % THD)
<b>Input sensitivity/Impedance</b>	450 mV, 50 kilohms

<b>Output sensitivity/Impedance</b>	TO TV: 450 mV, 1 kilohm External Center: 20 W (at 8 ohms, 1 kHz, 9 % THD), 8–16 ohms Rear: Accepts only supplied rear speakers SS-SR151 R-ch: Accepts only SA-VA10 R-ch speaker
-------------------------------------	---

<b>Tone control</b>	
<b>Front/Center</b>	Bass: ±10 dB at 100 Hz Treble: ±10 dB at 10 kHz

#### Speaker section

<b>Type</b>	
<b>Front speaker</b>	Bass reflex type
<b>DBR super woofer</b>	SAW type
<b>Rear speaker</b>	Bass reflex type

#### Speaker unit

<b>Front speaker system</b>	Center tweeter: 5 cm cone type (2) Front full range / Center woofer: 10 cm cone type (2) Super woofer: 13 cm cone type (1)
<b>Rear speaker</b>	8 cm cone type (2)

#### General

<b>Power requirement</b>	120 V AC, 60 Hz
<b>Front speakers</b>	

<b>Power consumption</b>	70 W
<b>Front speakers</b>	

<b>Dimensions</b>	Front left: Approx. 190 x 565 x 280 mm (w/h/d) (7 1/2 x 22 1/4 x 11 inches) Front right: Approx. 190 x 565 x 265 mm (w/h/d) (7 1/2 x 22 1/4 x 10 7/16 inches) Rear: Approx. 110 x 160 x 140 mm (w/h/d) (4 5/16 x 6 5/16 x 5 1/2 inches)
-------------------	---

<b>Mass</b>	Front (L): 9.0 kg (19 lb 13 oz) Front (R): 8.0 kg (17 lb 10 oz) Rear: 700 g/pc (1 lb 9 oz)
-------------	--

<b>Supplied accessories</b>	Rear speaker SS-SR151 (2) Front L/R speaker connecting cord, 3.5 m (1)
-----------------------------	---

- Rear speaker connecting cord, 10 m (2)
- Audio connecting cord, 1.5 m (1)
- Remote Commander RM-J10 (1)
- Sony batteries SUM-3 (NS) (2)
- Anti-vibration pads (8)

Design and specifications are subject to change without notice.

## Glossary

### Center mode

Speaker setting to enhance the Dolby Pro Logic Surround mode. Select one of the following four center modes according to your speaker system.

#### • NORMAL mode

Select NORMAL mode if you connect a small sized active center speaker to this speaker system. Since a small speaker cannot produce enough bass, the bass sound of the center channel is output from the front speakers.

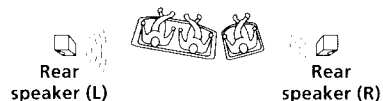
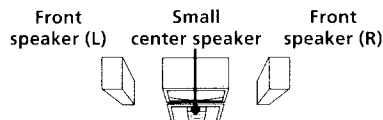

The test tone is output as shown on page 11.

#### • WIDE mode

Select WIDE mode if you connect an active center speaker equivalent to the two front speakers. With the WIDE mode, you can take full advantage of Dolby Surround sound.

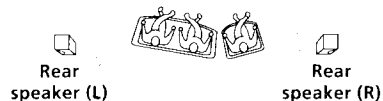
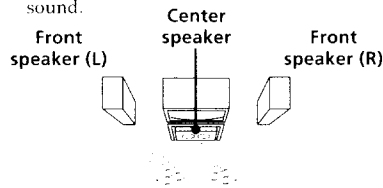

The test tone is output as shown on page 11.

#### • 3 CH LOGIC mode

Select 3 CH LOGIC mode if you don't want to use the rear speakers to output sound. The sound of the rear channel is output from the front speakers to let you experience some of the surround sound

without using rear speakers.

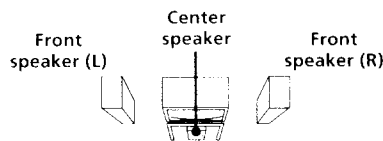

The test tone is output:



#### • PHANTOM mode

Select PHANTOM mode if you do not want to use the center speaker to output sound. The sound of the center channel is output from the front speakers.

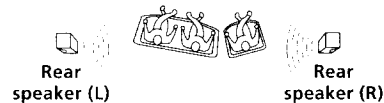

The test tone is output:

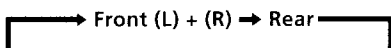

#### Delay time

Time lag between the surround sound output from front speakers and rear speakers. By adjusting the delay time of the rear speakers, you can obtain the feeling of presence. Make the delay time longer when you have placed the rear speakers in a small room or close to your listening position, and make it shorter when you have placed them in a large room or apart from your listening position.

#### Dolby Pro Logic Surround

Decoding system of Dolby Surround sound standardized in TV programs and movies. Compared with the former Dolby Surround system, Dolby Pro Logic Surround improves sound image by using four separate channels: off-screen audio effects, on-screen dialog, left-to-right panning, and music. These channels manipulate the sound to be heard and enhance the action as it happens on the screen. To take advantage of Dolby Pro Logic, you should have at least one pair of rear speakers and/or one center speaker. You also need to select the appropriate center mode to enjoy a full effect.

#### Dolby Surround

Encoding and decoding system of Dolby Surround sound for consumer use. Dolby Surround decodes the extra channels on the Dolby Surround-encoded sound tracks of movie videos and TV programs and produces sound effects and echoes that make the action seem to envelop you.

## Index

### A, B

- Adjusting
  - bass 12
  - delay time 12
  - speaker volume 11
  - super woofer level 11, 12
  - treble 12
  - volume 11
- Audio component hookups 9

### C

- Center mode 13, 15
  - NORMAL mode 13, 15
  - PHANTOM mode 13, 15
  - 3 CH LOGIC mode 13, 15
  - WIDE mode 13, 15
- Connecting. See Hookups

### D

- Delay time 12, 13, 15
- Dolby Pro Logic Surround 10, 15
  - center mode 13, 15
- Dolby Surround sound 15

### E, F, G

- External center speaker 13

### H, I, J, K, L, M

- Hookups
  - AC power cord 9
  - audio components 9
  - speakers 8
  - TV/VCRs 9

### N, O

- NORMAL mode 13, 15

### P, Q

- PHANTOM mode 13, 15

### R

- Remote 6, 10, 11, 12

### S

- Speakers
  - connection 8
  - placement 7
- Speaker volume 11
- Surround sound 10, 11, 12

### T

- Test tone 11
- 3 CH LOGIC mode 13, 15
- Troubleshooting 14
- TV/VCR hookups 9

### U, V

- Unpacking 6

### W, X, Y, Z

- WIDE mode 13, 15

