

Video Projector

Operating Instructions

Before operating the unit, please read this manual thoroughly and retain it for future reference.

VPL-VW1000ES



WARNING

To reduce the risk of fire or electric shock, do not expose this apparatus to rain or moisture.

To avoid electrical shock, do not open the cabinet. Refer servicing to qualified personnel only.

THIS APPARATUS MUST BE EARTHED.

For the customers in the U.S.A. and Canada

WARNING:

Using this unit at a voltage other than 120 V may require the use of a different line cord or attachment plug, or both. To reduce the risk of fire or electric shock, refer servicing to qualified service personnel.

For the customers in the U.S.A.

This equipment has been tested and found to comply with the limits for a Class B digital device, pursuant to part 15 of the FCC Rules. These limits are designed to provide reasonable protection against harmful interference in a residential installation. This equipment generates, uses and can radiate radio frequency energy and, if not installed and used in accordance with the instructions, may cause harmful interference to radio communications. However, there is no guarantee that interference will not occur in a particular installation. If this equipment does cause harmful interference to radio or television reception, which can be determined by turning the equipment off and on, the user is encouraged to try to correct the interference by one or more of the following measures:

- Reorient or relocate the receiving antenna.
- Increase the separation between the equipment and receiver.
- Connect the equipment into an outlet on a circuit different from that to which the receiver is connected.

- Consult the dealer or an experienced radio/TV technician for help.

You are cautioned that any changes or modifications not expressly approved in this manual could void your authority to operate this equipment.

All interface cables used to connect peripherals must be shielded in order to comply with the limits for a digital device pursuant to Subpart B of part 15 of FCC Rules.

If you have any questions about this product, you may call;

Sony Customer Information Service Center
1-800-222-7669 or <http://www.sony.com/>

Declaration of Conformity

Trade Name: SONY
Model: VPL-VW1000ES
Responsible party: Sony Electronics Inc.
Address: 16530 Via Esprillo,
San Diego, CA 92127
U.S.A.
Telephone Number: 858-942-2230

This device complies with part 15 of the FCC Rules. Operation is subject to the following two conditions: (1) This device may not cause harmful interference, and (2) this device must accept any interference received, including interference that may cause undesired operation.

For the customers in Canada

This Class B digital apparatus complies with Canadian ICES-003.

For the customers in Europe

This product has been manufactured by or on behalf of Sony Corporation, 1-7-1 Konan Minato-ku Tokyo, 108-0075 Japan. Inquiries related to product compliance based on European Union legislation shall be addressed to the authorized representative, Sony Deutschland GmbH, Hedelfinger Strasse 61, 70327 Stuttgart, Germany. For any service or guarantee matters, please refer to the addresses

provided in the separate service or guarantee documents.

AVERTISSEMENT

Afin de réduire les risques d'incendie ou d'électrocution, ne pas exposer cet appareil à la pluie ou à l'humidité.

Afin d'écartier tout risque d'électrocution, garder le coffret fermé. Ne confier l'entretien de l'appareil qu'à un personnel qualifié.

CET APPAREIL DOIT ÊTRE RELIÉ À LA TERRE.

Pour les clients au Canada

Cet appareil numérique de la classe B est conforme à la norme NMB-003 du Canada.

Pour les clients en Europe

Ce produit a été fabriqué par ou pour le compte de Sony Corporation, 1-7-1 Konan Minato-ku Tokyo, 108-0075 Japon. Toutes les questions relatives à la conformité des produits basées sur la législation européenne doivent être adressées à son représentant, Sony Deutschland GmbH, Hedelfinger Strasse 61, 70327 Stuttgart, Allemagne. Pour toute question relative au Service Après-Vente ou à la Garantie, merci de bien vouloir vous référer aux coordonnées qui vous sont communiquées dans les documents « Service (SAV) » ou Garantie.

WARNUNG

Um die Gefahr von Bränden oder elektrischen Schlägen zu verringern, darf dieses Gerät nicht Regen oder Feuchtigkeit ausgesetzt werden.

Um einen elektrischen Schlag zu vermeiden, darf das Gehäuse nicht geöffnet werden. Überlassen Sie Wartungsarbeiten stets nur qualifiziertem Fachpersonal.

DIESES GERÄT MUSS GEERDET WERDEN.

Für Kunden in Europa

Dieses Produkt wurde von oder für Sony Corporation, 1-7-1 Konan Minato-ku Tokio, 108-0075 Japan hergestellt.

Bei Fragen zur Produktkonformität auf Grundlage der Gesetzgebung der Europäischen Union kontaktieren Sie bitte den Bevollmächtigten Sony Deutschland GmbH, Hedelfinger Strasse 61, 70327 Stuttgart, Deutschland. Für Kundendienst oder Garantieangelegenheiten wenden Sie sich bitte an die in den Kundendienst- oder Garantiedokumenten genannten Adressen.

For kundene i Norge

Dette utstyret kan kobles til et IT-strømfordelingssystem.

Für Kunden in Deutschland

Entsorgungshinweis: Bitte werfen Sie nur entladene Batterien in die Sammelboxen beim Handel oder den Kommunen. Entladen sind Batterien in der Regel dann, wenn das Gerät abschaltet und signalisiert „Batterie leer“ oder nach längerer Gebrauchsdauer der Batterien „nicht mehr einwandfrei funktioniert“. Um sicherzugehen, kleben Sie die Batteriepole z.B. mit einem Klebestreifen ab oder geben Sie die Batterien einzeln in einen Plastikbeutel.

For the customers in Taiwan only



廢電池請回收

For the Customers in Brazil only

DESCARTE DE PILHAS E BATERIAS

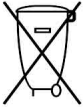

Após o uso, as pilhas e/ou baterias deverão ser entregues ao estabelecimento comercial ou rede de assistência técnica autorizada.

Pilhas e Baterias não recarregáveis

Atenção:

Verifique as instruções de uso do aparelho certificando-se de que as polaridades (+) e (-) estão no sentido indicado. As pilhas poderão vazar ou explodir se as polaridades forem invertidas, expostas ao fogo, desmontadas ou recarregadas.

Evite misturar com pilhas de outro tipo ou com pilhas usadas, transportá-las ou armazená-las soltas, pois aumenta o risco de vazamento.

Retire as pilhas caso o aparelho não esteja sendo utilizado, para evitar possíveis danos na eventualidade de ocorrer vazamento.

As pilhas devem ser armazenadas em local seco e ventilado.

No caso de vazamento da pilha, evite o contato com a mesma.

Lave qualquer parte do corpo afetado com água abundante.
Ocorrendo irritação, procure auxílio médico.

Não remova o invólucro da pilha.

Mantenha fora do alcance das crianças. Em caso de ingestão procure auxílio médico imediatamente.

DESCARTE DE PILHAS E BATERIAS

Este produto contém bateria de alimentação integrada (não removível pelo usuário) que só deve ser substituída por profissionais qualificados. Ao fim da vida útil do

equipamento, disponha-o em um ponto de coleta na Rede Autorizada Sony ou nas lojas Sony, de forma a garantir o tratamento adequado da bateria.

Note on use of the USB charging AC power adaptor AC-UD10

For the customer in the U.S.A.

The following FCC statement applies only to the version of this model manufactured for safe in the USA.

Other versions may not comply with FCC technical regulations.

This device complies with part 15 of the FCC Rules. Operation is subject to the following two conditions: (1) This device may not cause harmful interference, and (2) this device must accept any interference received, including interference that may cause undesired operation.

Table of Contents

Precautions	7
-------------------	---

Location of Controls

Front/Right Side	8
Rear/Bottom	9
Remote Control	10

Connections and Preparations

Unpacking	11
Inserting the Batteries into the Remote Control	11
Connecting the AC Power Cord	12
Preparation 1: Installing the Unit	13
Before Setting Up the Unit	13
Notes on Use	14
Installing the Unit	16
Preparation 2: Adjusting the Picture Position	17
Preparation 3: Connecting the Unit	22
Connecting to a VCR	22
Connecting to a Computer	24
Connecting to a 3D Sync Transmitter	25
Preparation 4: Selecting the Menu Language	26

Projecting

Projecting the Picture	27
------------------------------	----

Turning Off the Power	28
Watching 3D Video Images	28
Using the 3D Glasses	29
Charging the 3D Glasses	31
Using the Picture Position	32
Selecting the Aspect Ratio According to the Video Signal	34
Selecting the Picture Viewing Mode	37
Using the Supplied Software to Adjust the Picture Quality (ImageDirector3)	38

Using the Menus

Operation through the Menus	39
Picture Menu	41
Screen Menu	47
Setup Menu	50
Function Menu	52
Installation Menu	55
Information Menu	59
About the Preset Memory No. ...	59

Using Network Features

Displaying the Control Window of the Unit with a Web Browser	61
Operating the Control Window	62
Switching the Page	62
Setting the Access Limitation ...	62
Confirming the Information Regarding the Unit	62

Operating the Unit from a Computer	62
Using the E-mail Report Function	63

Others

About the Control for HDMI	65
About DCI specification	66
About the x.v.Color	66
About the simulated 3D feature	66
Troubleshooting	67
Warning Indicators	70
Message Lists	71
Replacing the Lamp and Cleaning the Ventilation Holes (intake)	73
Cleaning and the Screen of the Projector	76
Specifications	77
Preset Signals	79
Input Signals and Adjustable/ Setting Items	82
Compatible 3D Signals	84
3D Signals and Adjustable/Setting Items	84
Aspect Mode	85
Storage Conditions of Adjustable/ Setting Items	86
Projection Distance and Lens Shift Range	89
Dimensions	93
Index	96

Trademark Information

“PS3” is a registered trademark of Sony Computer Entertainment Inc.

The terms HDMI and HDMI High-Definition Multimedia Interface, and the HDMI Logo are trademarks or registered trademarks of HDMI Licensing LLC in the United States and other countries.

“Blu-ray” and “Blu-ray Disc” are trademarks of Blu-ray Disc Association.

.....
Control for HDMI is an HDMI standard mutual control function which uses the HDMI CEC (Consumer Electronics Control) specification. This projector supports DeepColor, x.v.Color, LipSync, 3D signal and computer input signal of HDMI standards. It also supports HDCP.

Precautions

On safety

- Check that the operating voltage of your unit is identical with the voltage of your local power supply.
- Should any liquid or solid object fall into the cabinet, unplug the unit and have it checked by qualified personnel before operating it further.
- Unplug the unit from the wall outlet if it is not to be used for several days.
- To disconnect the cord, pull it out by the plug. Never pull the cord itself.
- The wall outlet should be near the unit and easily accessible.
- The unit is not disconnected to the AC power source (mains) as long as it is connected to the wall outlet, even if the unit itself has been turned off.
- Do not look into the lens while the lamp is on.
- Do not place your hand or objects near the ventilation holes. The air coming out is hot.

On preventing internal heat build-up

After you turn off the power with the I/⏻ (ON/STANDBY) button, do not disconnect the unit from the wall outlet while the cooling fan is still running.

Caution

This unit is equipped with ventilation holes (intake) and ventilation holes (exhaust). Do not block or place anything near these holes, or internal heat build-up may occur, causing picture degradation or damage to the unit.

On repacking

Save the original shipping carton and packing material; they will come in handy if you ever have to ship your unit. For maximum protection, repack your unit as it was originally packed at the factory.

Safety precautions when using 3D Glasses

Warning

- Do not put the 3D Glasses in a fire.
- Do not disassemble the 3D Glasses.
- Do not use, charge, store, or leave the 3D Glasses near a fire, or in places with a high temperature, e.g., in direct sunlight, or in sun-heated cars.
- Use only the supplied USB cable.
- Do not charge the 3D Glasses with anything other than the supplied USB charging AC power adaptor.
- Do not allow water or foreign material to enter the 3D Glasses.

Safety precautions

- Use only the type of 3D glasses included with this unit. You should only use the 3D glasses for watching 3D video images. Do not use the 3D Glasses with other equipment, such as TV.
- If you observe flickering or flashing, turn off the lighting in the room.
- Not for use by children without proper adult supervision.
- Be careful not to pinch your fingers in hinges of the 3D glasses when bending the temple frames.
- Do not drop or modify these 3D glasses.
- If these glasses are broken, keep broken pieces away from your mouth or eyes.

Location of Controls

Front/Right Side

You can use the buttons on the control panel with the same names as those on the remote control to operate the unit.

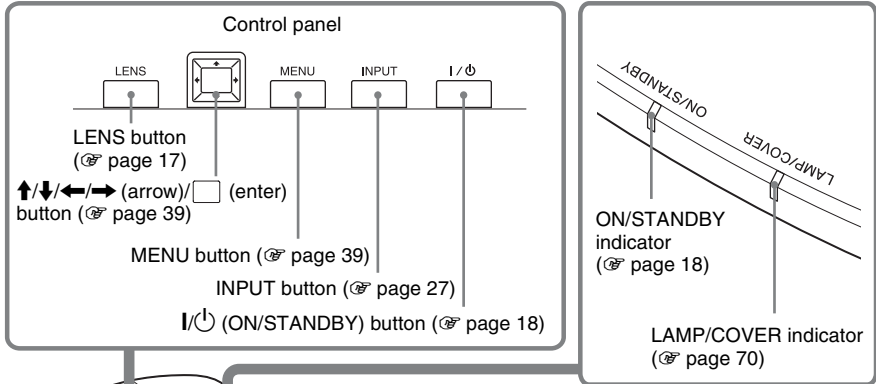

Note

While the ON/STANDBY indicator lights in orange, the power saving mode is on. (☞ page 51)

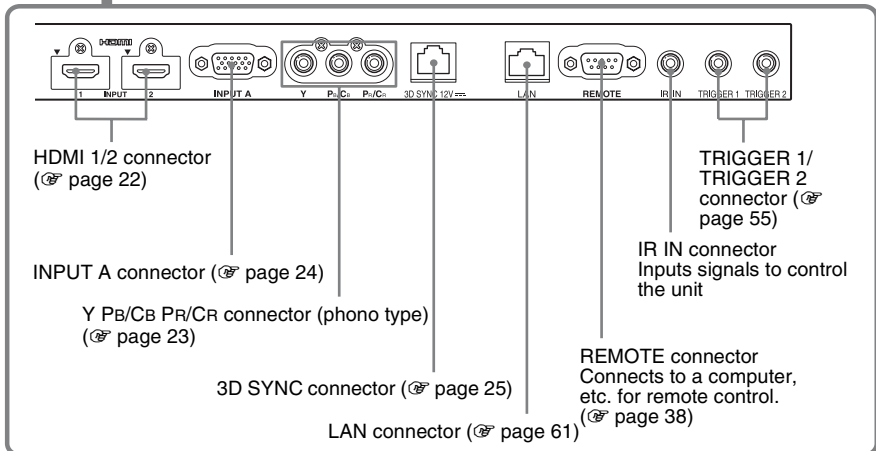
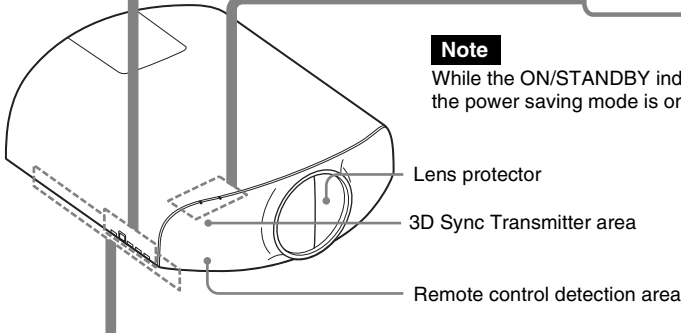

Rear/Bottom

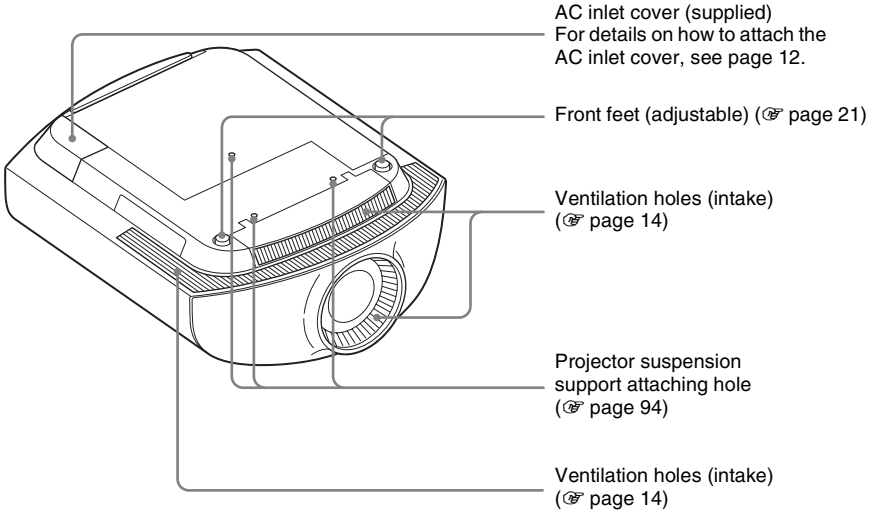
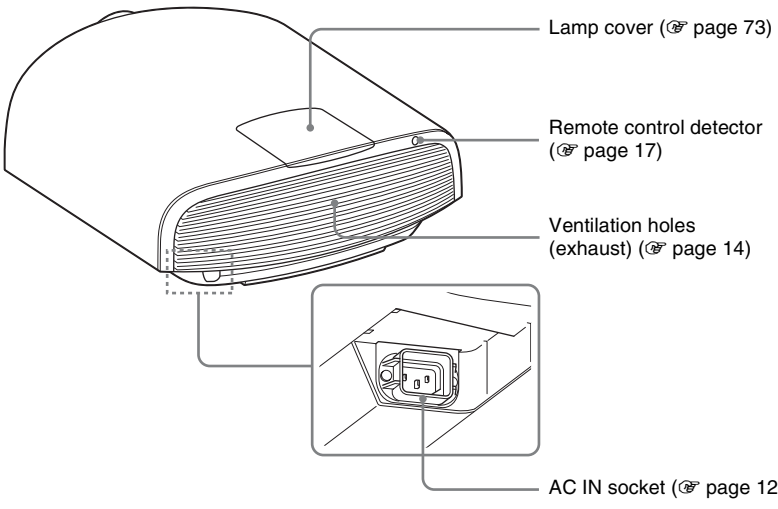

Remote Control

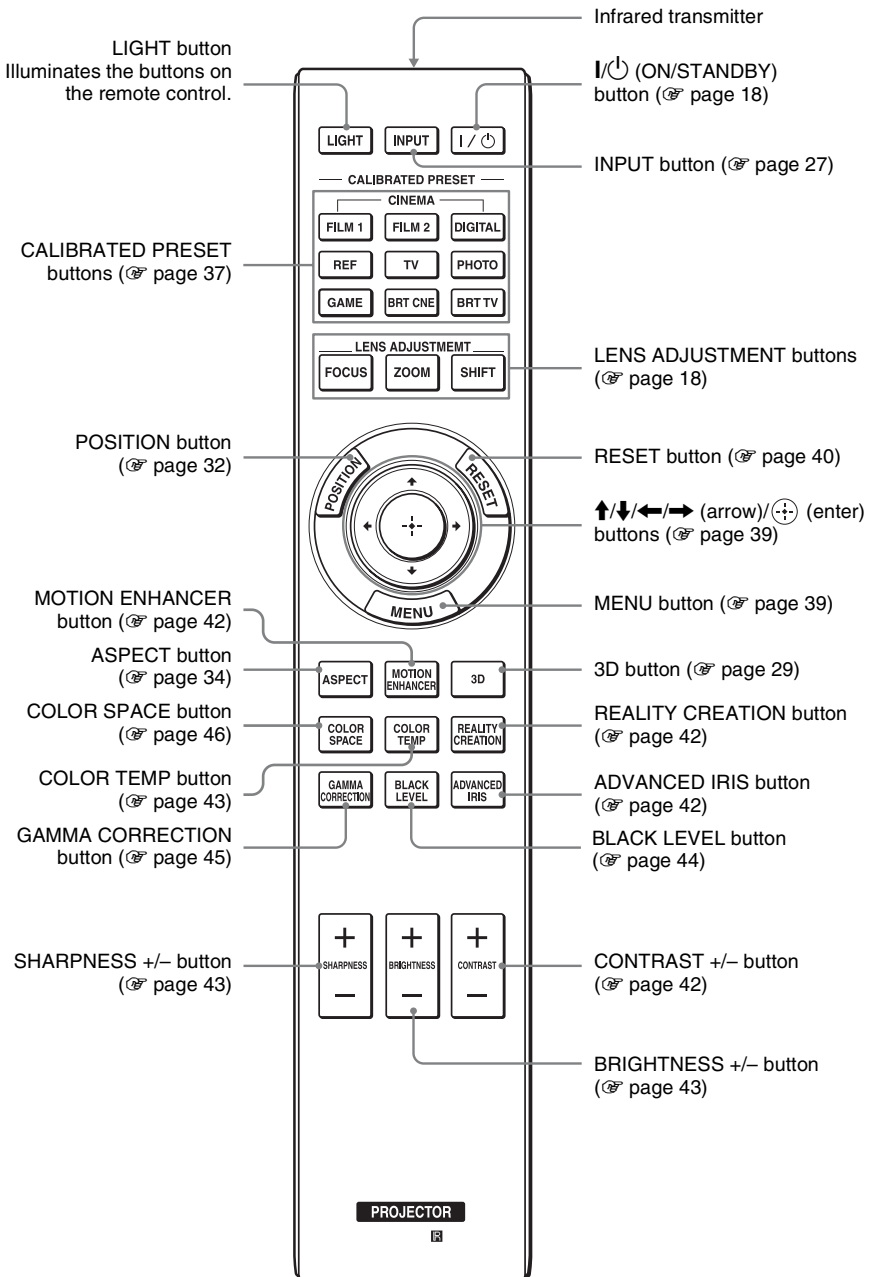

Connections and Preparations

This section describes how to install the unit and screen, how to connect the equipment from which you want to project the picture, etc.

Unpacking

Check the carton to make sure it contains the following items:

- Remote control (1)
- Size AA (R6) manganese batteries (2)

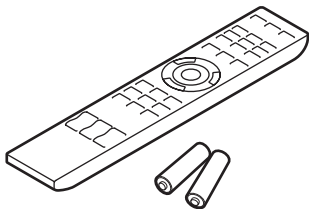

- AC power cord for the projector (1)
- Plug holder (1)
- AC inlet cover (1)
- 3D glasses (2)
- Pouch for the 3D glasses (2)
- USB charging AC power adaptor (1)
- AC power cord for USB charging AC power adaptor (1)
- USB charging cable (G2551-0077-00/-01 or APY5244-010020/SONY) (1.2 m) (1)
- ImageDirector3 CD-ROM (1)
- Operating Instructions (this manual) (1)

Inserting the Batteries into the Remote Control

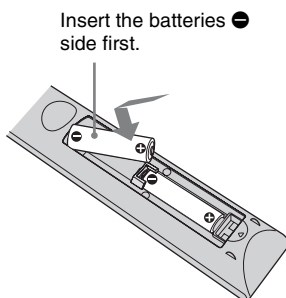
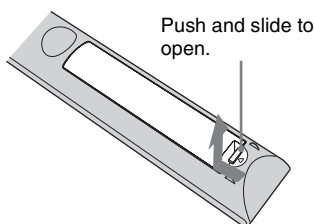

CAUTION

Danger of explosion if battery is incorrectly replaced.

Replace only with the same or equivalent type recommended by the manufacturer. When you dispose of the battery, you must obey the law in the relative area or country.

ATTENTION

Il y a danger d'explosion s'il y a remplacement incorrect de la batterie. Remplacer uniquement avec une batterie du même type ou d'un type équivalent recommandé par le constructeur. Lorsque vous mettez la batterie au rebut, vous devez respecter la législation en vigueur dans le pays ou la région où vous vous trouvez.

VORSICHT

Explosionsgefahr bei Verwendung falscher Batterien. Batterien nur durch den vom Hersteller empfohlenen oder einen gleichwertigen Typ ersetzen.

Wenn Sie die Batterie entsorgen, müssen Sie die Gesetze der jeweiligen Region und des jeweiligen Landes befolgen.

Installing batteries

Two size AA (R6) batteries are supplied for Remote Control.

To avoid risk of explosion, use size AA (R6) manganese or alkaline batteries.

Caution about handling the remote control

- Handle the remote control with care. Do not drop or step on it, or spill liquid of any kind onto it.
- Do not place the remote control in a location near a heat source, a place subject to direct sunlight, or a damp room.

Connecting the AC Power Cord

- 1 Plug the AC power cord into the AC IN socket, then attach the plug holder to the AC power cord.**

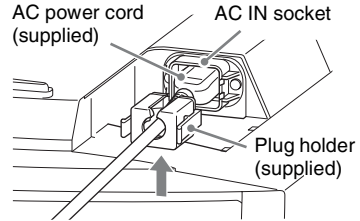

- 2 Slide the plug holder over the AC power cord to fix to the unit.**

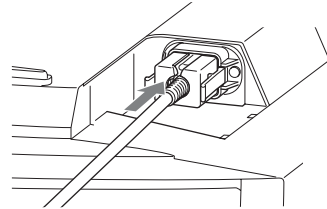

- 3 Attach the AC inlet cover to the unit.**

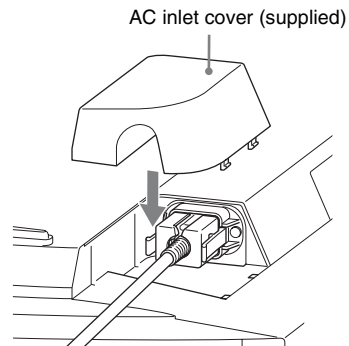

Preparation 1: Installing the Unit

The lens shift allows you to have broader options for placing the unit and viewing pictures easily.

Before Setting Up the Unit

Unsuitable installation

Do not place the unit in the following situations, which may cause malfunction or damage to the unit.

Near walls

To maintain the performance and reliability of the unit, leave space between walls and the unit as illustrated.

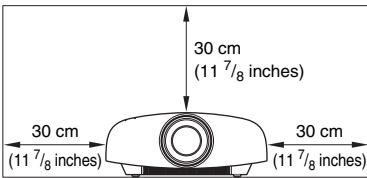

Leave a space of at least 5 cm (2 inches) between the wall and the exhaust port side of the unit. Note that the wall behind the unit may become hot.

Poorly ventilated location

Leave space of more than 30 cm (11 7/8 inches) around the unit.

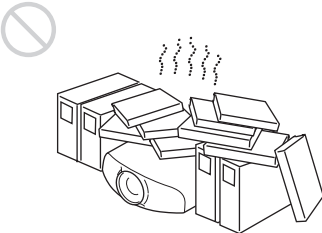

Hot and humid



Locations subject to direct cool or warm air from an air-conditioner

Installing the unit in such a location may cause a malfunction of the unit due to moisture condensation or rise in temperature.

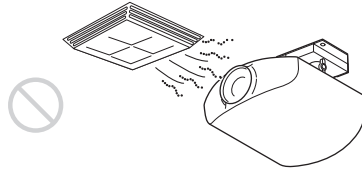

Near a heat or smoke sensor

Malfunction of the sensor may occur.

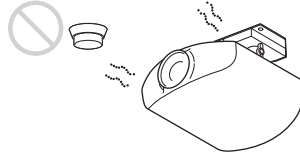

Very dusty and extremely smoky locations



Notes on Use

Do not do any of the following while using the unit.

Blocking the ventilation holes (intake or exhaust)

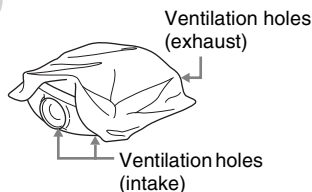

For details on the location of the ventilation holes (intake or exhaust), see “Location of Controls” on page 8.

Tilting front/rear and left/right

Avoid using the unit tilted at an angle of more than 15 degrees.

Do not install the unit anywhere other than on a level surface or on the ceiling. Installing the unit in such a location may result in uneven color uniformity or reduce the reliability of the effects of the lamp.

If the unit is tilted up or down, the image on the screen may be trapezoidal.

Position the unit so that the lens is parallel to the screen (☞ page 16).

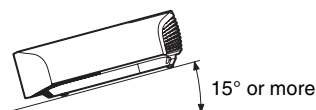
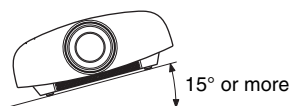

15° or more

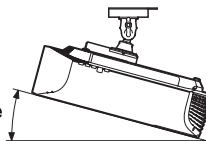

15° or more

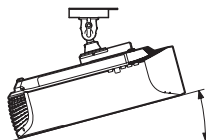

When installing the unit at high altitudes

When using the unit at an altitude of 1,500 m or higher, set “Cooling Setting” on the Setup  menu to “High” (☞ page 50).

Failing to set this mode when using the unit at high altitudes could have adverse effects, such as reducing the reliability of certain components.

WARNING

When installing the unit, incorporate a readily accessible disconnect device in the fixed wiring, or connect the power plug to an easily accessible socket-outlet near the unit. If a fault should occur during operation of the unit, operate the disconnect device to switch the power supply off, or disconnect the power plug.

AVERTISSEMENT

Lors de l'installation de l'appareil, incorporer un dispositif de coupure dans le câblage fixe ou brancher la fiche d'alimentation dans une prise murale facilement accessible proche de l'appareil. En cas de problème lors du fonctionnement de l'appareil, enclencher le dispositif de coupure d'alimentation ou débrancher la fiche d'alimentation.

WARNUNG

Beim Einbau des Geräts ist daher im Festkabel ein leicht zugänglicher Unterbrecher einzufügen, oder der Netzstecker muss mit einer in der Nähe des Geräts befindlichen, leicht zugänglichen Wandsteckdose verbunden werden. Wenn während des Betriebs eine Funktionsstörung auftritt, ist der Unterbrecher zu betätigen bzw. der Netzstecker abzuziehen, damit die Stromversorgung zum Gerät unterbrochen wird.

Installing the Unit

The installation distance between the unit and a screen varies depending on the size of the screen or whether or not you use the lens shift features. Install this unit so that it fits the size of your screen. For details on the distance between the unit and the screen (the projection distance) and the size of projected video, see “Projection Distance and Lens Shift Range” (📄 page 89).

1 Position the unit so that the lens is parallel to the screen.

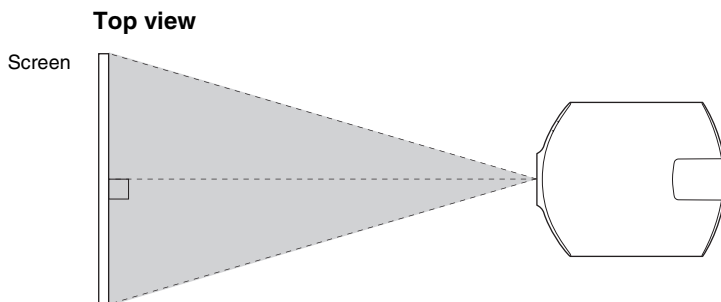

2 Project an image on the screen and adjust the picture so that it fits the screen (📄 page 17).

Note

When using a screen with an uneven surface, stripes pattern may rarely appear on the screen depending on the distance between the screen and the unit or the zooming magnifications. This is not a malfunction of the unit.

When installing the unit on the ceiling

Caution

Do not mount the projector on the ceiling or move it by yourself. Be sure to consult with qualified Sony personnel (charged).

To dealers

Use the Sony PSS-H10 Projector Suspension Support, and take measures to prevent falling using wire, etc.

For details, refer to the installation manual for dealers of the PSS-H10.

Preparation 2: Adjusting the Picture Position

Project an image on the screen and then adjust the picture position.

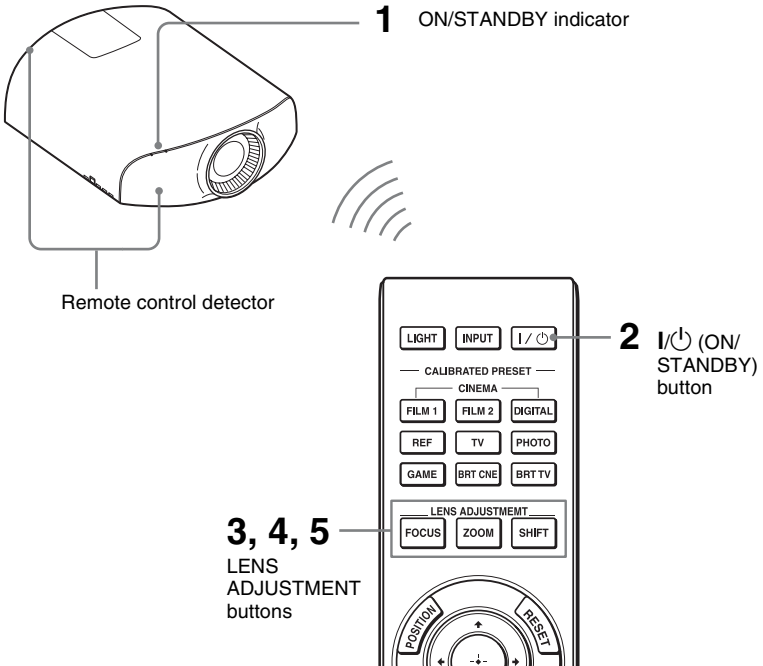

Tips

- The I/ON/STANDBY, INPUT, MENU, and $\uparrow/\downarrow/\leftarrow/\rightarrow/\square$ (joystick) buttons on the side panel of the unit function the same as those on the remote control. The LENS button functions in the same way as the LENS ADJUSTMENT (FOCUS, ZOOM, SHIFT) buttons of the remote control.
- When adjusting the lens, each time you press the LENS button on the unit, the lens adjustment function switches between “Lens Focus,” “Lens Zoom” and “Lens Shift.”

FOCUS → ZOOM → SHIFT

Note

Depending on the installation location of the unit, you may not control it with the remote control. In this case, point the remote control at the remote control detector of the unit or the screen.

1 After connecting the AC power cord to the unit, plug the AC power cord into a wall outlet.

The ON/STANDBY indicator lights in red and the unit goes into standby mode.

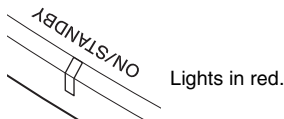

2 Press the I/⏻ (ON/STANDBY) button to turn on the unit.

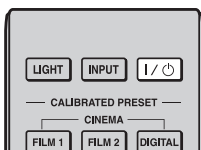

The lens protector will open. The ON/STANDBY indicator flashes in green, and then lights in green.

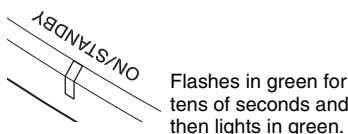

3 Adjust the focus.

Press the LENS ADJUSTMENT (FOCUS) button to display the Lens Focus adjustment window (test pattern). Then adjust the focus of the picture by pressing the $\uparrow/\downarrow/\leftarrow/\rightarrow$ buttons.

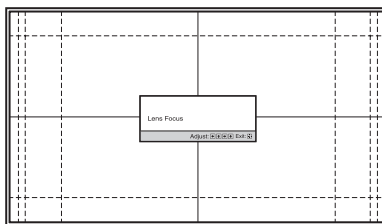
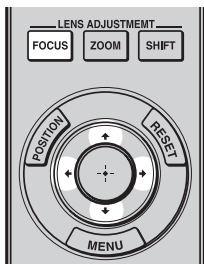

Tip

When “Lens Control” is set to “Off” on the Installation \mathcal{M} menu, you cannot adjust the focus, the picture size or the proper position by pressing the FOCUS, ZOOM or SHIFT buttons (\mathcal{C} page 55).

When “Test Pattern” is set to “Off” on the Function \mathcal{M} menu, the test pattern is not displayed (\mathcal{C} page 54).

Note

Adjust the lens by using buttons on the remote control or the control panel of the unit. Never make adjustments by directly turning the lens with your hands, which may cause damage or malfunction to the unit.

4 Adjust the picture size.

Press the LENS ADJUSTMENT (ZOOM) button to display the Lens Zoom adjustment window (test pattern). Then adjust the size of the picture by pressing the $\uparrow/\downarrow/\leftarrow/\rightarrow$ buttons. To make the picture larger, press \uparrow/\rightarrow . To make the picture smaller, press \downarrow/\leftarrow .

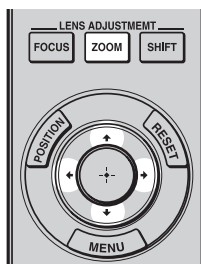

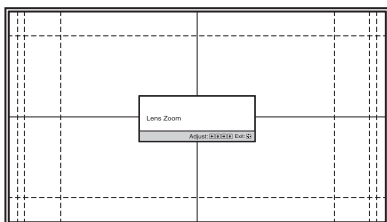

5 Adjust the picture position.

Press the LENS ADJUSTMENT (SHIFT) button to display the Lens Shift adjustment window (test pattern). Then adjust to the proper position of the picture by pressing the $\uparrow/\downarrow/\leftarrow/\rightarrow$ buttons.

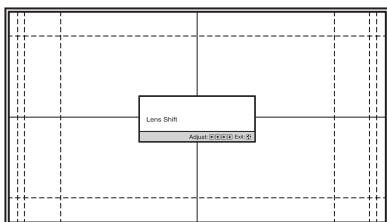

Tip

The test pattern disappears when no operation has been performed for one minute. Whenever you press the \oplus button, the test pattern disappears.

Note

When adjusting the window position, do not touch the lens unit, otherwise your fingers may be pinched by the moving parts.

To adjust the horizontal position



Press ←/→.

The picture projected on the screen moves right or left by a maximum of 31% of the screen width from the center of the lens.

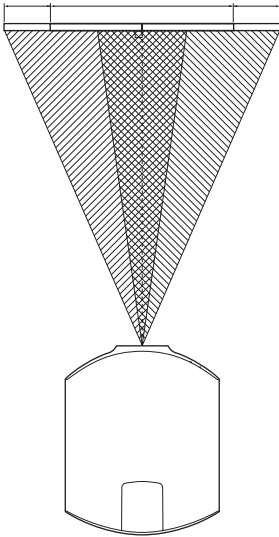
31% 1 screen width 31%



Top view

-  : Picture position when moving the picture to the left at maximum
-  : Picture position when moving the picture to the right at maximum



To adjust the vertical position

Press ↑/↓.

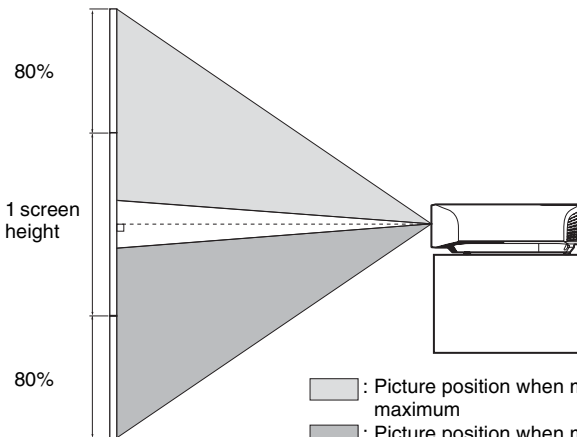
The picture projected on the screen moves up or down by a maximum of 80% of the screen height from the center of the lens.



Side view

-  : Picture position when moving the picture upward at maximum
-  : Picture position when moving the picture downward at maximum

Note

The range to move the picture projected on the screen can be adjusted only within the octagon area illustrated below. For details, see “Projection Distance and Lens Shift Range” (☞ page 89).

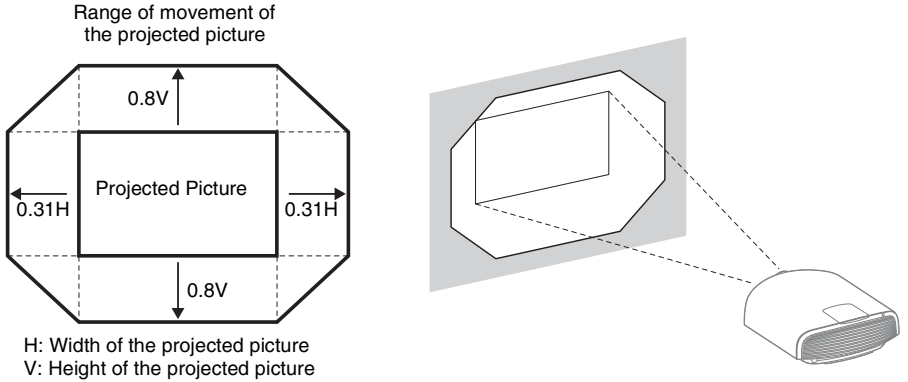

To adjust the tilt of the installation surface

If the unit is installed on an uneven surface, use the front feet (adjustable) to keep the unit level.

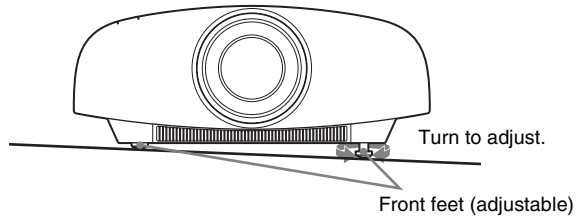

Notes

- If the unit is tilted up or down, the projected image may be trapezoidal.
- Be careful not to catch your finger when turning the front feet (adjustable).

Lens adjustment window (test pattern)

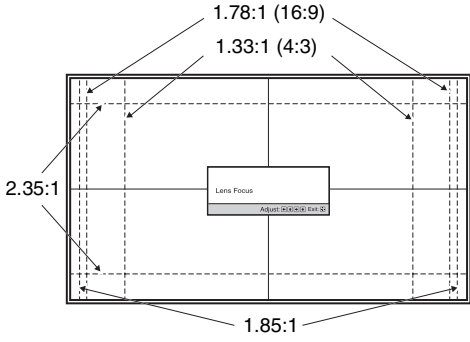

The dashed lines show the screen sizes of each aspect ratio.



Preparation 3: Connecting the Unit

When making connections, be sure to do the following:

- Turn off all equipment before making any connections.
- Use the proper cables for each connection.
- Insert the cable plugs properly; poor connection at the plugs may cause a malfunction or poor picture quality. When pulling out a cable, be sure to pull it out from the plug, not the cable itself.
- Refer to the operating instructions of the connected equipment.

Connecting to a VCR

To connect to equipment with HDMI output connectors

You can enjoy better picture quality by connecting a DVD player/recorder, Blu-ray Disc player/recorder, or PS3[®] equipped with HDMI output to the HDMI input of the unit. Moreover, if you have a Control for HDMI compatible equipment, you can operate the unit synchronizing with the Control for HDMI compatible equipment. For details, see “HDMI Setting” of the Function  menu ( page 53) and “About the Control for HDMI” ( page 65).

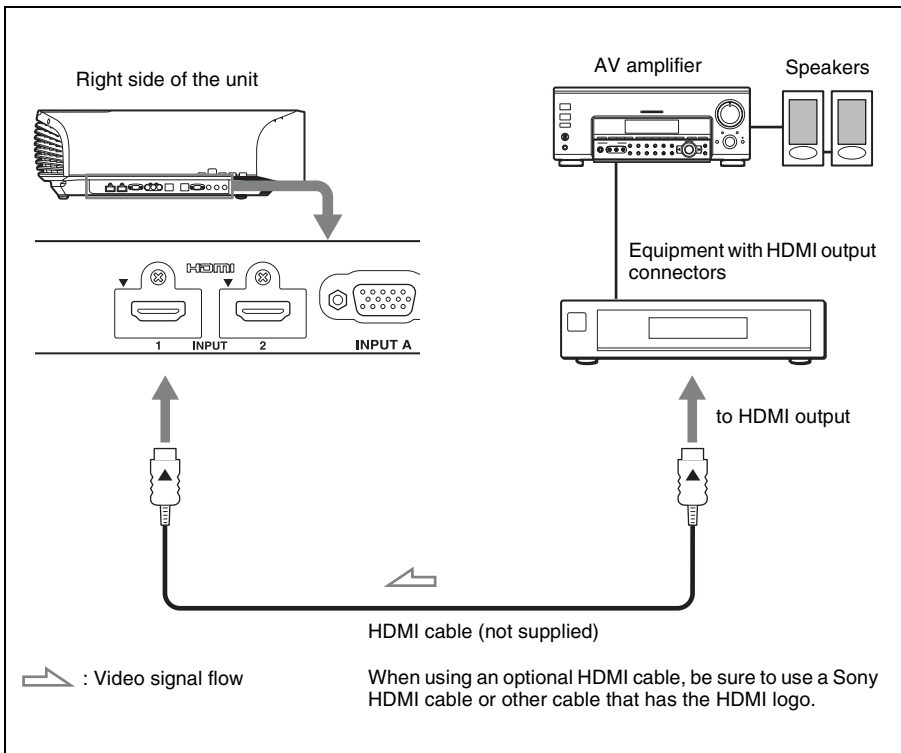

Notes

- Use a high-speed HDMI cable. With a standard HDMI cable, images of 1080p, DeepColor, 3D video and 4K video may not be displayed properly.
- When connecting an HDMI cable to the unit, make sure the ▼ mark on the upper part of the HDMI input of the unit and the ▲ mark on the connector of the cable is set at the same position.
- If the picture from equipment connected to the unit with an HDMI cable is not correct, check the settings of the connected equipment.

To connect to equipment with component video output connectors

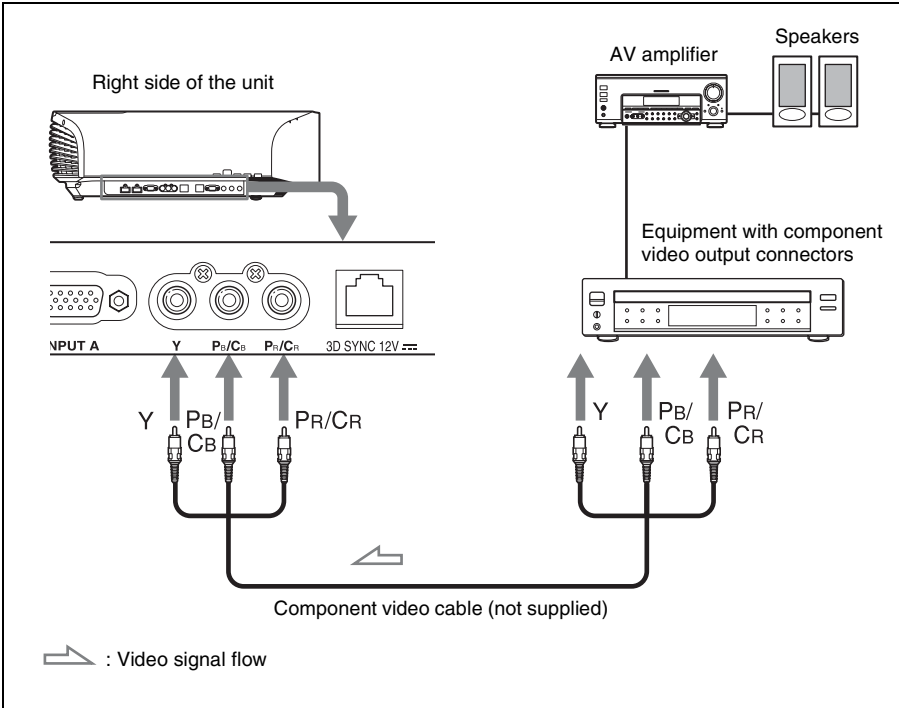

Connecting to a Computer

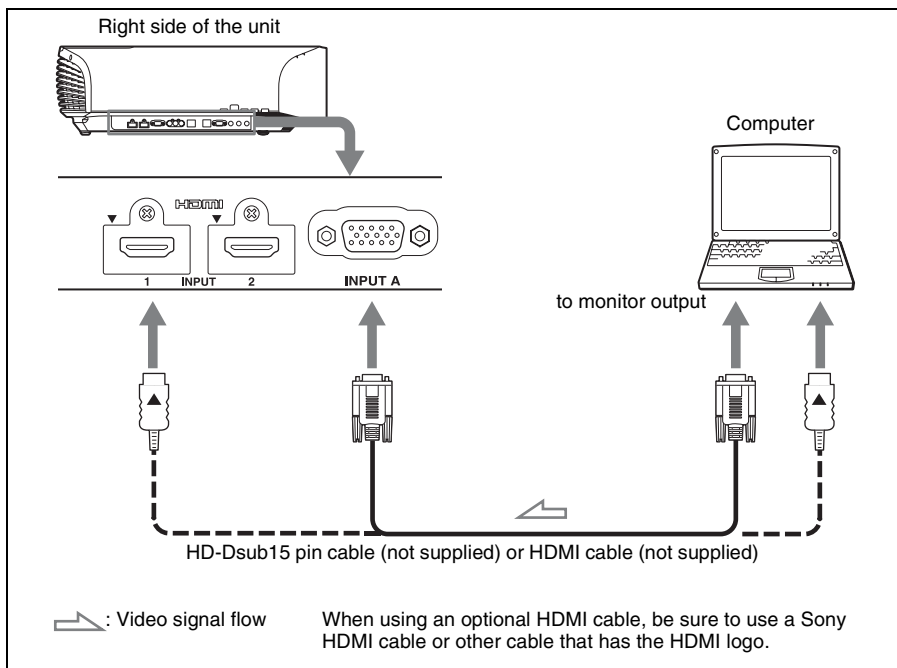

Notes

- Use a high-speed HDMI cable. With a standard HDMI cable, images of 1080p video may not be displayed properly.
- When connecting an HDMI cable, make sure the ▼ mark on the upper part of the HDMI input of the unit and the ▲ mark on the connector of the cable is set at the same position.
- If you set your computer, such as a notebook type, to output the signal to both computer's display and this equipment, the picture of the equipment may not appear properly. Set your computer to output the signal to only the external monitor.
For details, refer to the computer's operating instructions supplied with your computer. For settings of the computer, consult with the manufacturer of the computer.
- If the picture from equipment connected to the unit with an HDMI cable is not correct, check the settings of the connected equipment.

Connecting to a 3D Sync Transmitter

This unit incorporates a 3D Sync Transmitter. Depending on the installation environment of the unit, the 3D glasses may not receive 3D signals properly from the unit's built-in 3D Sync Transmitter. In this case, connect an optional 3D Sync Transmitter and place it near your viewing position.

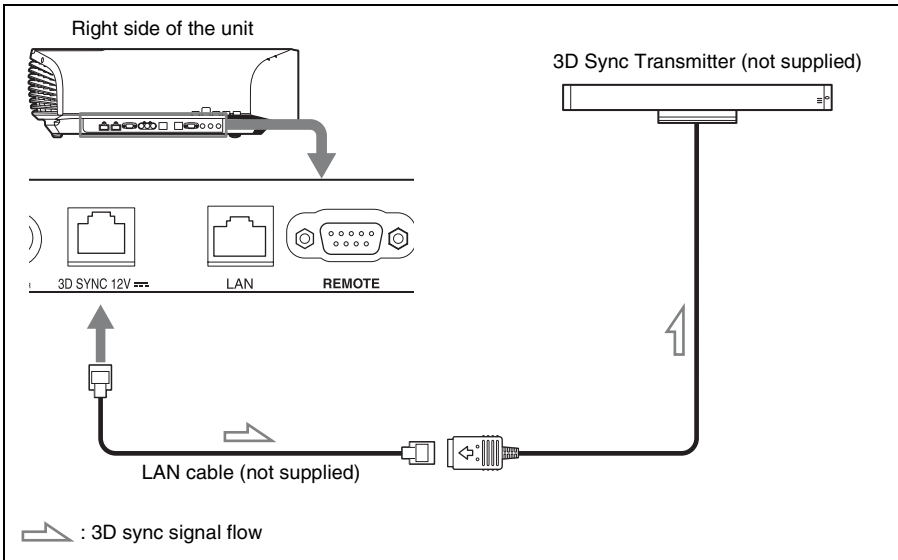

Tip

Place the optional 3D Sync Transmitter directly facing the 3D glasses. Also, in order to stabilize operation of the 3D glasses, it is recommended that you place the 3D Sync Transmitter near your viewing position.

CAUTION

Be sure to use straight-type LAN cable of up to 15 m labeled TYPE CM, and do not use an extension cord.

Notes

- The 3D SYNC connector is dedicated for the optional 3D Sync Transmitter. Do not connect computers or other network devices, to avoid malfunction.
- You can use a 3D Sync Transmitter separate from this unit, using an optional LAN cable (straight-type).
If the usage environment has interference of a continuous specific frequency, synchronization of 3D image signals and the 3D glasses may be lost. In this case, use a LAN cable labeled Category 7. When watching 3D images in an environment that has even more interference, use the internal transmitter.
- Be sure to use cable of up to 15 m, and do not use an extension cord. Also, keep the LAN cable away from any AC power cords as much as possible.
- Only one 3D Sync Transmitter should be connected to the unit. Connecting multiple 3D Sync Transmitters may cause a malfunction.
- When connected to the 3D Sync Transmitter, the built-in 3D Sync Transmitter feature of the unit will turn off. You cannot use both at the same time.

Preparation 4: Selecting the Menu Language

You can select one of 16 languages for displaying the menu and other on-screen displays. The factory default setting is English. To change the current menu language, set the desired language with the menu screen.

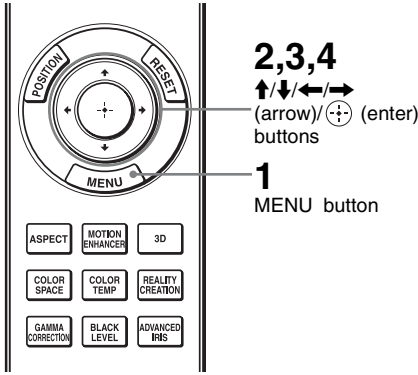

1 Press MENU.

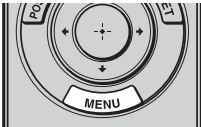

The menu appears.

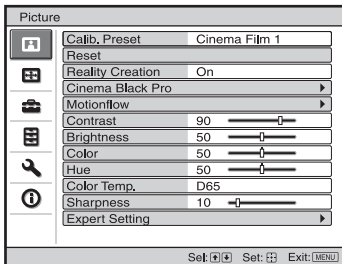

2 Press ↑/↓ to select the Setup menu, and press → or (enter).

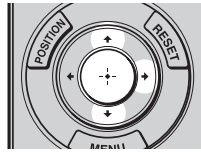

The setting items of the selected menu appear.

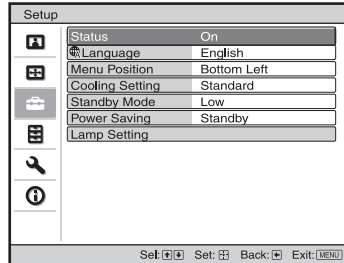

3 Press ↑/↓ to select “Language,” and press → or (enter).

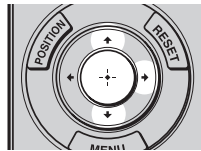

4 Press ↑/↓/←/→ to select a language, and press (enter).

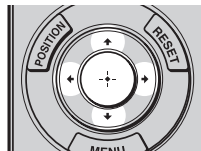

The menu changes to the selected language.

To clear the menu

Press MENU.

Projecting

This section describes how to operate the unit to view the picture from the equipment connected to the unit. It also describes how to adjust the quality of the picture to suit your taste.

Projecting the Picture

- 1 Power on both the unit and the equipment connected to the unit.**
- 2 Press INPUT to display the input palette on the screen.**

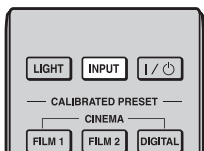

- 3 Select the equipment from which you want to display images.**

Press INPUT repeatedly or press \uparrow/\downarrow (enter) to select the equipment from which to project.

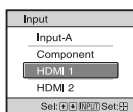

Example: To view the picture from the video equipment connected to the HDMI 1 connector of this unit.

To view the picture from	Press INPUT to display
RGB equipment connected to the INPUT A connector	Input-A
Component equipment connected to the Y Pb/Cb Pr/Cr connector	Component
Equipment connected to the HDMI 1 connector	HDMI 1
Equipment connected to the HDMI 2 connector	HDMI 2

Tips

- When “Auto Input Search” is set to “On” on the Function [Menu] menu, only input terminals with effective signals are displayed in the input palette.
- When “Status” is set to “Off” on the Setup [Setup] menu, the input palette does not appear. Press the INPUT button to switch between input terminals in sequence.
- When the “Control for HDMI” is set to “On” on the Function [Menu] menu, the input terminal with effective signals is automatically displayed, synchronizing with the operation of the equipment connected to HDMI 1 or HDMI 2 input of the unit. (Only when the connected equipment supports Control for HDMI compatible.)

Turning Off the Power

1 Press the I/⏻ (ON/STANDBY) button.

A message “POWER OFF?” appears on the screen.

2 Press the I/⏻ (ON/STANDBY) button again before the message disappears.

The lens protector will close. Be careful not to catch your fingers or any objects. The ON/STANDBY indicator flashes in green and the fan continues to run to reduce the internal heat. First, the ON/STANDBY indicator flashes quickly, during which you will not be able to light up the ON/STANDBY indicator with the I/⏻ (ON/STANDBY) button.

The fan stops and the ON/STANDBY indicator changes from flashing green to remaining red.

The power is turned off completely, and you can disconnect the AC power cord.

Note

Never disconnect the AC power cord while the indicator is flashing.

You can turn off the unit by holding the I/⏻ (ON/STANDBY) button for about 1 second, instead of performing the above steps.

Watching 3D Video Images

You can enjoy powerful 3D video images, such as from 3D games and 3D Blu-ray Discs, using the supplied 3D glasses.

1 Turn on the HDMI equipment for 3D compatibility connected to the unit, then play the 3D content.

For details on how to play 3D content, refer to the operating instructions for the connected equipment.

2 Turn on the unit and project the 3D video image onto the screen.

For details on how to project the image, see “Projecting the Picture” (📖 page 27).

3 Turn on the 3D glasses, and then put them on so that they fit comfortably.

For details on how to use the 3D glasses, see “Using the 3D Glasses” (📖 page 29).

Tips



- The factory default setting for “2D-3D Display Sel.” is “Auto” to allow projecting 3D video images automatically when the unit detects 3D signals.
- To convert 3D video images to 2D video images, set “2D-3D Display Sel.” to “2D” (📖 page 52).

Notes

- It may not be possible to display 3D video image, depending on the type of signal. Set the “2D-3D Display Sel.” to “3D,” and “3D Format” to “Side-by-Side” or “Over-Under” to suit the format of the 3D content you want to watch (📖 page 52).
- Use the 3D glasses within the communication range (📖 page 30).

- You can watch 3D video images only when signals from HDMI input. When connecting 3D equipment such as a 3D game or 3D Blu-ray Disc player to the unit, use an HDMI cable.
- There are differences in perception of 3D video images among individuals.
- When the temperature of the usage environment is low, the 3D effect may be diminished.

Adjusting/Setting the 3D functions

You can adjust/set the 3D functions by pressing the 3D button on the remote control or with the “3D Settings” of the Function  menu. For details, see “3D Settings” ( page 52).

Using the 3D Glasses

The 3D glasses receive signals from the 3D Sync Transmitter built into the front of the unit, which are reflected to the glasses from the screen. When watching 3D video images using the 3D glasses, face squarely toward the screen.

1 Press the power button on the 3D glasses.

The LED indicator lights up in green.

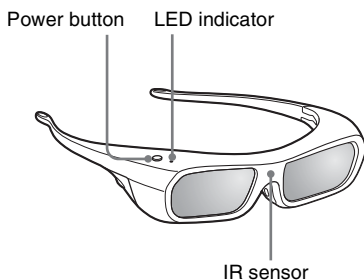

2 Put on the 3D glasses.

3 Turn toward the screen.

Precautions for use

The 3D glasses receive infrared signals sent by the 3D Sync Transmitter built into the front of the unit, which are reflected to the glasses from the screen.

Misoperation may occur if:

- The 3D glasses do not face the screen
- There are objects blocking the path between the 3D glasses and the screen
- The viewing position is too far from the screen or the distance between the unit and screen is too great
- There are other infrared communication devices nearby

3D glasses communication range

Figures A and B below indicate the communication range of the 3D glasses. If you try to watch 3D video images from a distance greater than the communication range or install the unit outside the communication range, the 3D glasses may not be able to display the images properly. Also, the viable angles and distance vary depending on the screen type, environment of the room, and installation environment of the unit.

Figure A: 3D sync signal communication distance (Shift Range: 0.5 V)

Side view

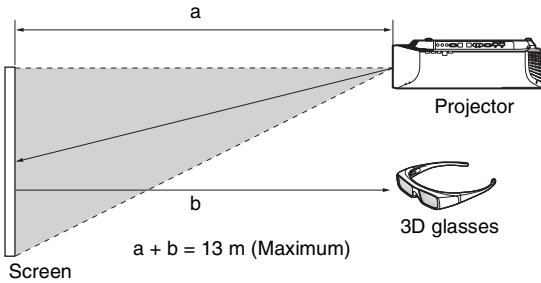
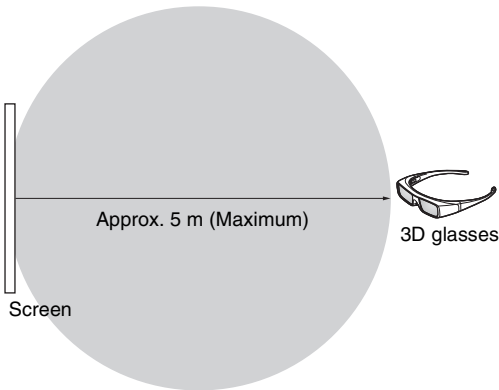

Figure B: 3D glasses communication range (The figure shows the distance between the screen and the projector as 8 m.)

Top or side view



Charging the 3D Glasses

Use the provided USB charging AC power adaptor to charge your 3D glasses.

Caution

Connect the USB charging cable supplied with the unit, to the supplied USB charging AC power adaptor only.

Using any other connector may cause fire, a rise in temperature or damage to the cable and glasses.

- 1 Turn off the power of the 3D glasses.
- 2 Open the 3D glasses cover and connect the USB charging cable supplied with the unit.

Open the cover.

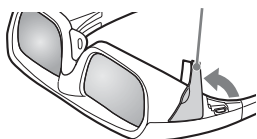

Supplied USB cable

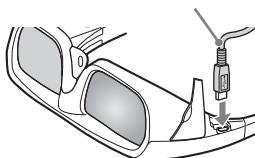

- 3 Connect the USB cable to the USB connector of the supplied USB charging AC power adaptor.

Supplied USB charging AC power adaptor

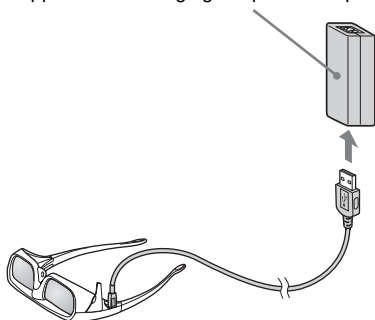

- 4 Connect the AC power cord for USB charging AC power adaptor to the supplied USB charging AC power adaptor.

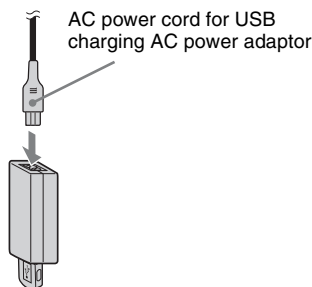

- 5 Plug the AC power cord for USB charging AC power adaptor into an AC outlet.

Charging starts. The LED indicator on the 3D glasses lights up in orange while the glasses are being charged. (After charging finishes, the LED indicator turns off.)

Precautions about USB charging AC power adaptor

Installation

Do not place the USB charging AC power adaptor in a location where it is:

- Subject to extreme high temperature (E.g., in a car with its windows closed)
- Subject to direct sunlight or near a heat source
- Subject to mechanical vibration or shock

Operation

- To prevent damage, be careful not to drop or otherwise cause a mechanical shock to the unit.
- After using, disconnect the unit from the AC outlet and the equipment.
- Disconnect the unit from the AC outlet by pulling on the plug. Do not pull on the cord.
- To avoid short-circuiting, do not allow the terminals of the USB charging AC power adaptor or connector to touch any metal object.

Cleaning

- Clean the unit with a soft, dry cloth. If the unit is very dirty, wipe it off with a soft cloth lightly moistened with a mild detergent solution, and then wipe with a soft dry cloth.
- Do not use any type of solvent such as alcohol, thinner, or benzine as it may damage the finish of the cabinet.
- If you use any chemical cleaner, observe the instructions provided with the product.
- If the cabinet of the unit is splashed with any type of solvent such as insecticide, or remains in contact for a long time with rubber or vinyl, the finish of the cabinet may be damaged.

Using the Picture Position

You can store up to five combinations of lens settings (focus, window size, window position) and aspect ratio, and you can recall those settings.

1 Press the POSITION button.

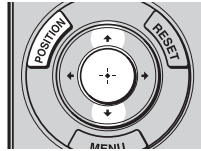

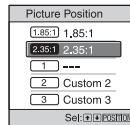

The Picture Position selecting palette is displayed.



2 Press the POSITION button repeatedly, or press the // buttons to select the position.

The settings of the position selected is recalled.

Store or delete the lens settings and aspect ratio in the “Picture Position” of the Screen  menu ( page 47).

A position where lens settings and aspect ratio are not stored is displayed as “---.”

Image of the lens moving

In the example below, the images with aspect ratio of 1.78:1 (16:9) and 2.35:1 are projected on a 2.35:1 screen.

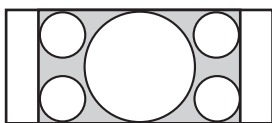

When a 1.78:1 (16:9) image is input



When a 2.35:1 image is input



Press the POSITION button.

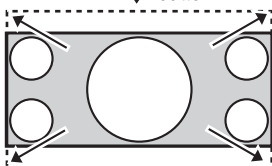

The 2.35:1 image expands to fill the screen.

Notes

- After you have selected and confirmed the lens position, the lens starts to move. Do not touch, or place anything near, the lens, otherwise it may cause injury or a malfunction.
- If you press any button on the unit while the lens is moving, the lens stops. In this case, select the lens position again or adjust the lens manually.
- The Picture Position function is not guaranteed to reproduce the lens settings precisely.
- When you use the subtended screen angle of two or more aspects using lens zoom, install the unit within the specified parameters referring to “Projection distance” (☞ page 90). With some setting positions, the range of lens shift may be restricted, even though the unit is installed within the specified parameters.

Selecting the Aspect Ratio According to the Video Signal

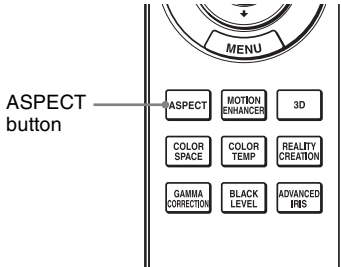

You can select an aspect ratio best suited for the video signal received.

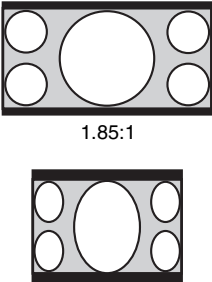
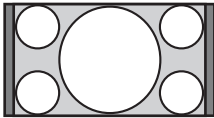
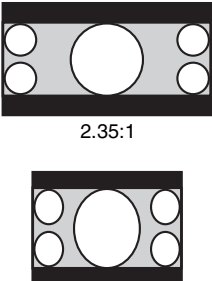
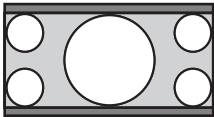

Press ASPECT.

Each time you press the button, you can select the “Aspect” setting. You can also select it using the menu (🔍 page 48).

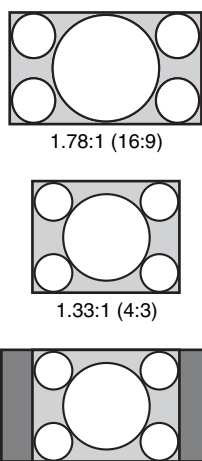
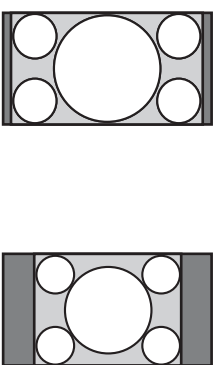
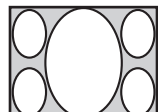
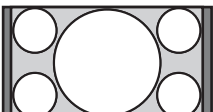
Original image	Recommended setting and resultant images
 <p>1.85:1</p> <p>Squeezed 1.85:1</p>	<p>1.85:1 Zoom</p> 
 <p>2.35:1</p> <p>Squeezed 2.35:1</p>	<p>2.35:1 Zoom</p> 

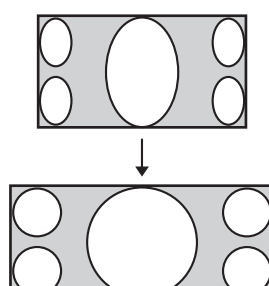
Original image	Recommended setting and resultant images
 <p>1.78:1 (16:9)</p> <p>1.33:1 (4:3)</p> <p>1.33:1 (4:3) with side panels</p>	<p>Normal</p> 
 <p>Squeezed</p>	<p>Stretch</p> 
 <p>2.35:1</p>	<p>V Stretch</p>  <p>When using an anamorphic lens</p>

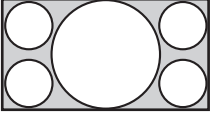
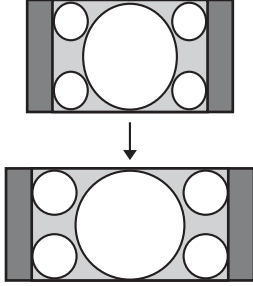
Original image	Recommended setting and resultant images
 <p data-bbox="318 293 356 312">16:9</p>	<p data-bbox="748 132 827 151">Squeeze</p>  <p data-bbox="645 464 930 483">When using an anamorphic lens</p>

Notes

- Selectable aspect modes vary depending on the input signal. (Ⓞ page 85)
- The aspect cannot be selected for an input signal from a computer, or when preset memory number 96 (Ⓞ page 80) signal is input.

Notes on switching the “Aspect” setting

- Select the aspect mode taking into account that changing the aspect ratio of the original picture will provide a different look from that of the original image.
- Note that if the unit is used for profit or for public viewing, modifying the original picture by switching the aspect may constitute an infringement of the rights of authors or producers, which are legally protected.

Selecting the Picture Viewing Mode

You can select the picture viewing mode that best suits the type of video source or room conditions.

You can save and use different preset modes for 2D/3D respectively.

Press one of the CALIBRATED PRESET buttons.

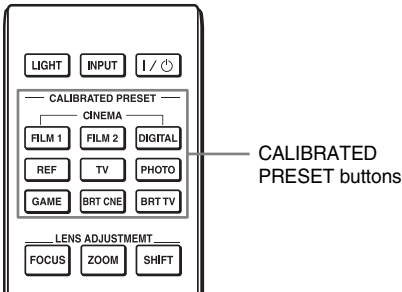



Setting items	Description
CINEMA FILM 1	Picture quality suited to reproducing the highly dynamic and clear images typical of master positive film.
CINEMA FILM 2	Picture quality suited to reproducing the rich tone and color typical of a movie theater.
CINEMA DIGITAL	Picture quality suited to reproducing digital cinema-like images resembling DCI specifications (see page 66).
REF	A picture quality setup suitable for when you want to reproduce faithfully the original image quality, or for enjoying image quality, without any adjustment.
TV	Picture quality suited for watching TV programs, sports, concerts, etc.
PHOTO	Ideal for projecting still images taken with a digital camera.
GAME	Picture quality suited to gaming, with well-modulated colors and fast response.
BRT CINE	Picture quality suited for watching movies in a bright environment, such as a living room.
BRT TV	Picture quality suited for watching TV programs, sports, concerts, and other video images in a bright environment, such as a living room.

Using the Supplied Software to Adjust the Picture Quality (ImageDirector3)

By using the “ImageDirector3” (supplied as a CD-ROM), you can make the desired gamma correction from a computer connected to the unit. Connect the REMOTE or LAN connector of the unit to a computer, then launch “ImageDirector3” on the computer. For details on how to use the “ImageDirector3,” refer to the Help within the CD-ROM.

Notes

- You need to install the “ImageDirector3” on a computer beforehand.
- When connecting the REMOTE or LAN connector to a computer, connect with both the computer and unit turned off.
- You can perform adjustment with “ImageDirector3” when “Gamma Correction” in the Picture  menu (🔍 page 45) is set to 1.8, 2.0, 2.1, 2.2, 2.4, or 2.6. Adjustment is not possible when it is set to Gamma 7 to 10 and Off.
- Before using “ImageDirector3,” use the Picture  menu to set “Gamma Correction” to 1.8, 2.0, 2.1, 2.2, 2.4, or 2.6. In “ImageDirector3,” the display is Gamma 1, Gamma 2, Gamma 3, Gamma 4, Gamma 5 and Gamma 6 respectively.
- If you use “ImageDirector3” while a 3D video image is displayed or a 3D signal is input, the image may be distorted.

Using the Menu

This section describes how to make various adjustments and settings using the menu.

Operation through the Menu

The unit is equipped with an on-screen menu for making various adjustments and settings. If you select an item name followed by an arrow (▶), the next menu window with setting items appears.

1 Press MENU.

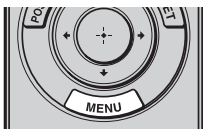

The menu window appears.

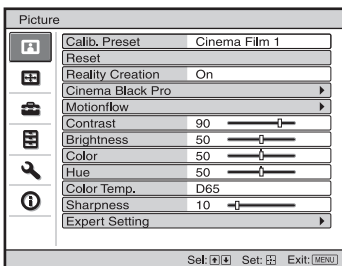

2 Press ↑/↓ to select a menu item, and press → or ◂.

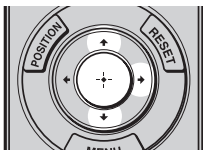

The items that can be set or adjusted with the selected menu appear. The item presently selected is shown in white.

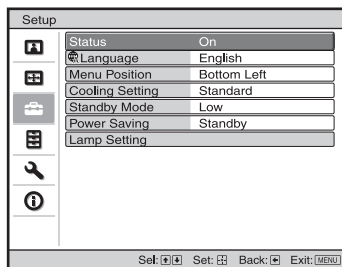

3 Press ↑/↓ to select an item you want to set or adjust and press → or ◂.

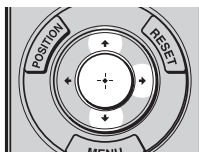

The setting items are displayed in a pop-up menu, in an adjustment menu or in the next menu window.

Pop-up menu

Setting items



Setting menu

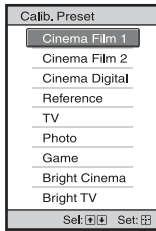

Adjustment menu

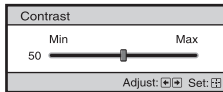

Next menu window

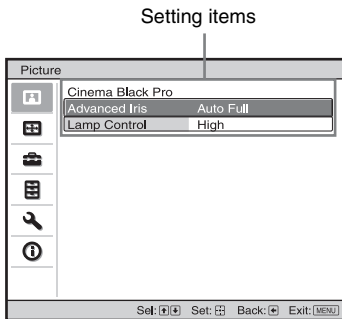

4 Make the setting or adjustment of an item.

When changing the adjustment level

To increase the value, press **↑/→**.

To decrease the value, press **↓/←**.

Press **⊕** to store the setting and restore the original menu screen.

When changing the setting

Press **↑/↓** to change the setting.

Press **⊕** to restore the original screen.

You can restore the original screen using **←** depending on the selected item.

To clear the menu

Press MENU.

To reset the picture that has been adjusted

Select "Reset" from the Picture **ⓘ** menu.

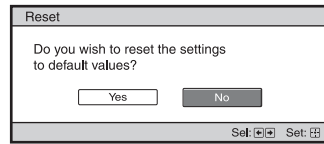

When the screen display appears, select "Yes" using **←** and press **⊕**.

All of the following settings are reset to its factory preset value:

"Reality Creation," "Cinema Black Pro,"

"Motionflow," "Contrast," "Brightness,"

"Color," "Hue," "Color Temp.,"

"Sharpness," and "Expert Setting" on the Picture **ⓘ** menu

To reset the items that have been adjusted

Select an item in the menu screen, and display the pop-up menu, the setting menu, or the adjustment menu.

Press RESET on the remote control to reset only the selected settings to its factory preset value.

Note

The RESET button on the remote control is available only when the adjustment menu or the setting menu is selected.

Picture Menu

The Picture menu is used for adjusting the picture.

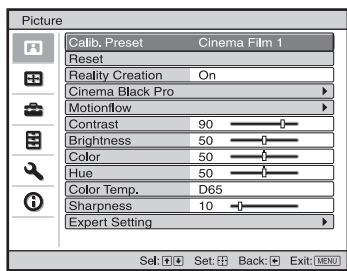

Note

These items may not be available, depending on the type of input signal. For details, see “Input Signals and Adjustable/Setting Items” (pages 82 to 85).

Item names in brackets represent those printed on the remote control.

<p>Calib. Preset [CALIBRATED PRESET]</p>	<p>You can select the picture viewing mode that best suits the type of video source or the environment.</p> <p>You can save and use different preset modes for 2D/3D respectively.</p> <p>Cinema Film 1: Picture quality suited to reproducing the highly dynamic and clear images typical of master positive film.</p> <p>Cinema Film 2: Picture quality suited to reproducing the rich tone and color typical of a movie theater.</p> <p>Cinema Digital: Picture quality suited to reproducing digital cinema-like images resembling DCI specifications (page 66).</p> <p>Reference: A picture quality setup suitable for when you want to reproduce faithfully the original image quality, or for enjoying image quality, without any adjustment.</p> <p>TV: Picture quality suited for watching TV programs, sports, concerts, etc.</p> <p>Photo: Ideal for projecting still images taken with a digital camera.</p> <p>Game: Picture quality suited to gaming, with well-modulated colors and fast response.</p> <p>Bright Cinema: Picture quality suited for watching movies in a bright environment, such as a living room.</p> <p>Bright TV: Picture quality suited for watching TV programs, sports, concerts, and other video images in a bright environment, such as a living room.</p> <p>Tip Any adjustments to picture quality settings are saved for each input.</p>
<p>Reset</p>	<p>Resets all currently selected Calib. Preset mode settings to their default values (page 40).</p> <p>Tip Reset does not affect settings saved for the Custom 1 to 5 items of “Color Temp.”</p>

Reality Creation [REALITY CREATION]	<p>Adjusts the detail and noise processing of images. (Super-resolution function)</p> <p>On: Applies detail and noise processing effects.</p> <p>Resolution: When you increase the setting value, the texture and detail of the picture become sharper.</p> <p>Noise Filtering: When you increase the setting value, the noise (picture roughness) becomes less prominent.</p> <p>Off: The “Reality Creation” function is not applied.</p>
Cinema Black Pro	<p>Advanced Iris [ADVANCED IRIS] Switches the iris function.</p> <p>Auto Full: Automatically adjusts to optimize the iris aperture according to the brightness level of the input source. Moreover, signal processing, which optimizes gradation expression between the peak light and dark parts, expresses a large dynamic range. This results in a bright and high contrast image.</p> <p>Auto Limited: A lower brightness than Auto Full, making the image suitable for viewing in a dark room.</p> <p>Manual: Manually (fixed) adjusts the iris.</p> <div data-bbox="555 571 777 663" style="text-align: center;"> </div> <p>Off: Disables the iris (aperture) function.</p> <p>Lamp Control Switches the lamp output.</p> <p>High: Increases the brightness, and projects brighter images.</p> <p>Low: Decreases the brightness, and enhances blacks by minimizing brightness.</p> <p>Tip Setting “Low” reduces fan noise, while also reducing energy consumption for longer lamp life.</p>
Motionflow	<p>Film Projection Reproduces an image similar to that of projected film. Use this setting as preferred, based on the image content.</p> <p>On: Reduces afterimage.</p> <p>Off: The reduction effect of afterimage is less than the “On” setting. The picture will become brighter.</p> <p>Motion Enhancer [MOTION ENHANCER] Reproduces fast-moving pictures smoothly without generating afterimages.</p> <p>High: Select this for picture quality smoother than “Low.”</p> <p>Low: Select this for smooth picture quality.</p> <p>Off: Select this to not apply the motion enhancer function.</p> <p>Tip Certain scenes may contain digital signal artifacts. In this case, set this function to “Off.”</p>
Contrast [CONTRAST]	<p>Adjusts the contrast. Higher values increase the sharpness in images, while lower values decrease the sharpness.</p> <p>You can make adjustments by pressing the CONTRAST +/- on the remote control.</p>

Brightness [BRIGHTNESS]	Adjusts the brightness of the picture. The higher the setting, the brighter the picture. The lower the setting, the darker the picture. You can make adjustments by pressing the BRIGHTNESS +/- on the remote control.
Color	Adjusts the color density. The higher the setting, the greater the intensity. The lower the setting, the lower the intensity.
Hue	Adjusts the color tone. The higher the setting, the more greenish the picture becomes. The lower the setting, the more reddish the picture becomes.
Color Temp. [COLOR TEMP]	Adjusts the color temperature. D93: Equivalent to 9,300 K color temperature normally used in TVs. Gives white colors a blue tint. D75: Equivalent to 7,500 K color temperature used as an ancillary standard illuminant. Gives a neutral tint between “D93” and “D65.” D65: Equivalent to 6,500 K color temperature used as a standard illuminant. Gives white colors a red tint. DCI: DCI specification (☞ page 66) color temperature. D55: Equivalent to 5,500 K color temperature used as an ancillary standard illuminant. Gives white colors an even redder tint. Custom 1 to 5: Enables you to adjust, set, and store your favorite color temperature. The factory default settings are as follows. Custom 1: Same as “D93” color temperature setting. Custom 2: Same as “D75” color temperature setting. Custom 3: Same as “D65” color temperature setting. Custom 4: Same as “DCI” color temperature setting. Custom 5: Same as “D55” color temperature setting.
Sharpness [SHARPNESS]	Sharpens the outline of the picture, or reduces the noise. The higher the setting, the sharper the picture. The lower the setting, the softer the picture, thus reducing the noise. You can make adjustments by pressing the SHARPNESS +/- on the remote control.

Expert Setting	<p>NR (Noise Reduction) Reduces the roughness or noise of the picture. Usually, use to select “Off.” If the picture is rough or noisy, select a setting from among “Low,” “Middle” or “High” according to the input signal source.</p>
	<p>MPEG NR (MPEG Noise Reduction) Reduces block noise and mosquito noise, in particular in digital signals. Usually, use to select “Off.” If the picture is rough or noisy, select a setting from among “Low,” “Middle” or “High” according to the input signal source.</p>
	<p>Smooth Gradation Smooths the gradation of the flat parts of images. High/Middle/Low: You can adjust the smooth gradation effect. Off: The smooth gradation function is not applied.</p>
	<p>Film Mode According to the film source you have selected, make a setting for playback. Auto 1: Suitable for reproducing the original picture movement. Normally, set this to “Auto 1.” Auto 2: Reproduces a 2-3 or 2-2 Pull-Down format video signal, such as film sources, in a smooth picture movement. When a video signal other than 2-3 or 2-2 Pull-Down format is input, the picture is played back in progressive format. Off: Plays back the picture in progressive format without detecting video signals automatically.</p>
	<p>Black Level Adj. (Adjust) [BLACK LEVEL] Emphasizes blacks and strengthens the contrast. High/Middle/Low: You can adjust the black level. Off: The black level function is not applied.</p>

Expert Setting	<p>Gamma Correction [GAMMA CORRECTION] Adjusts the response characteristics of the tone of the picture. Select a favorite tone from 10 options.</p> <p>1.8: Bright Produces a brighter picture overall.</p> <p>2.0</p> <p>2.1</p> <p>2.2</p> <p>2.4</p> <p style="text-align: center;">↑ ↓</p> <p>2.6: Dark Produces a darker picture overall.</p> <p>Gamma 7: Brightens dark areas in the picture, and expands gradation expression.</p> <p>Gamma 8: Produces a picture with contrast emphasized slightly.</p> <p>Gamma 9: Produces a picture with contrast emphasized more than with Gamma 8.</p> <p>Gamma 10: Simulates the gamma curve of film.</p> <p>Off: Gamma Correction is not applied.</p> <p>Using the specified controller, “ImageDirector3” (☞ page 38) (supplied as a CD-ROM) allows you to adjust, set, and store a favorite tone in a computer.</p> <p>For detailed information on “ImageDirector3,” refer to the Help provided on the supplied CD-ROM in the computer.</p> <p>Tip You can adjust with “ImageDirector3” when “Gamma Correction” is set to 1.8, 2.0, 2.1, 2.2, 2.4, or 2.6. Adjustment is not possible with Gamma 7 to 10 and Off.</p>
	<p>Color Correction On: Optimizes midrange colors, based on the color space setting. Off: The “Color Correction” effect is not applied.</p>
	<p>Clear White Emphasizes vivid whites. High/Low: You can adjust the “Clear White” effect. Off: The “Clear White” effect is not applied.</p>
	<p>x.v.Color Set this item when playing back an x.v.Color video signal. Set this item to “On” when connecting the unit with equipment that supports x.v.Color and playing back an x.v.Color video signal. For details on x.v.Color, see “About the x.v.Color” (☞ page 66).</p> <p>Tip Setting x.v.Color to “On” disables gamma adjustment.</p>

<p>Expert Setting</p>	<p>Color Space [COLOR SPACE] Converts the color space. BT.709: An ITU-R BT.709 color space, which is used for high-definition television broadcast or Blu-ray Disc. The color space is equivalent to sRGB. DCI: A color space based on the DCI specification (see page 66). Adobe RGB: An approximated Adobe RGB color space, which has a wider range of color reproduction than sRGB, and suited for displaying an image recorded in Adobe RGB specification. Color Space 1: The color space suited for watching TV programs and video images, such as sport, concerts, etc. Color Space 2: The color space suited for watching TV programs, sport, concerts, and other video images in a bright environment, such as a living room. Color Space 3: The color space suited for watching movies in a bright environment, such as a living room.</p>
------------------------------	--

Screen Menu

You can set the input signal, picture size, aspect mode, etc.

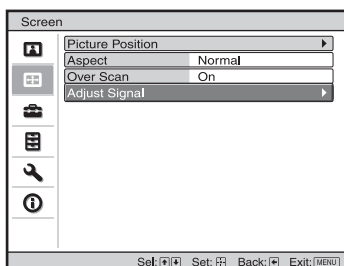

Note

These items may not be available, depending on the type of input signal. For details, see “Input Signals and Adjustable/Setting Items” (🔗 pages 82 to 85).

Item names in brackets represent those printed on the remote control.

<p>Picture Position [POSITION]</p>	<p>You can store up to five combinations of lens settings (focus, window size, window position) and aspect ratio. After setting the lens and aspect, select from “1.85:1,” “2.35:1,” “Custom 1,” “Custom 2” or “Custom 3” depending on the subtended screen angle, and after confirming, continue by selecting “Save,” “Delete,” or “Select.” Save: Stores the current lens settings in the selected position. If a setting is already stored in that position, it is overwritten. Delete: Deletes the stored setting. After the setting is deleted, “1.85:1,” “2.35:1,” “Custom 1,” “Custom 2,” or “Custom 3” in the display change to “---.” Select: Recalls the settings of the selected position.</p> <p>Tip The optimal aspect ratio is preset for each picture position. The aspect ratio can be changed and saved for each picture position.</p> <p>Notes</p> <ul style="list-style-type: none"> • After you have selected and confirmed the lens position, the lens starts to move. Do not touch the lens and the area around the lens, otherwise it may cause injury or a malfunction. • If you press any button on the unit while the lens is moving, the lens stops. In this case, select the lens position again or adjust the lens manually. • When you use a 2.35:1 or a 16:9 subtended screen angle with the Picture Position function, make sure that the installation position is suitable (🔗 page 32). • The Picture Position function is not guaranteed to reproduce the lens settings precisely.
---	--

Aspect [ASPECT]	<p>You can set the aspect ratio of the picture to be displayed for the current input signal (🔗 page 34). This item is enabled only when a video signal (preset memory numbers 3 to 14 and 93 to 95) (🔗 page 79) is input.</p> <p>1.85:1 Zoom: A 1.85:1 aspect ratio picture is displayed in its original aspect ratio, enlarged so that black bands do not appear at the top and bottom of the screen.</p> <p>2.35:1 Zoom: A 2.35:1 aspect ratio picture is displayed in its original aspect ratio, enlarged so that black bands at the top and bottom of the screen are as small as possible.</p> <p>When you select “2.35:1 Zoom” from “Trigger Select 1/2” on the Installation 🗑️ menu, a 12 V signal is output from the TRIGGER 1 or TRIGGER 2 connector (🔗 page 55).</p> <p>Normal: Input video is displayed in its original aspect ratio, enlarged to fill the screen. This mode is suitable for viewing 1.78:1 (16:9) and 1.33:1 (4:3) video.</p> <p>Stretch: Displays video that has been squeezed to 1.33:1 (4:3) as 1.78:1 (16:9) aspect ratio.</p> <p>V Stretch: This is the most suitable mode for using a 2.35:1 screen to view 2.35:1 video with a commercially available anamorphic lens.</p> <p>When you select “V Stretch” from “Trigger Select 1/2” on the Installation 🗑️ menu, a 12 V signal is output from the TRIGGER 1 or TRIGGER 2 connector (🔗 page 55).</p> <p>Squeeze: With this setting, 1.78:1 (16:9) and 1.33:1 (4:3) video will be displayed in their correct aspect ratios when you use a commercially available anamorphic lens.</p> <p>Tips</p> <ul style="list-style-type: none"> • When you select “V Stretch” or “Squeeze,” select the anamorphic lens type from “Anamorphic Lens” in the Installation 🗑️ menu. • Selectable aspect modes vary depending on the input signal. • The aspect cannot be selected for an input signal from a computer.
Over Scan	<p>You can select whether or not to display the outline of the picture.</p> <p>On: Hides the outline of the input picture. Select this setting when noise appears along the edge of the picture.</p> <p>Off: Projects the whole of the input picture.</p> <p>Tip</p> <p>To display the displayable region within the four directions of the screen, see “Blanking” on the Installation 🗑️ menu (🔗 page 56).</p>

Adjust Signal	<p>You can adjust the input signal setting.</p> <p>Phase: Adjusts the pixel/signal phase of an analog computer input signal. Adjusts the picture to the point where it looks clearest.</p> <p>Pitch: Adjusts the horizontal picture size of an analog computer input signal. As the number increases, the picture becomes wider, and as the number decreases, the picture becomes narrower. Adjust the setting to match the number of dots of the input signal.</p> <p>Shift: Adjusts the position of the picture.</p> <p>H: As the setting for H (horizontal) increases, the picture moves to the right, and as the setting decreases, the picture moves to the left. Use ◀/▶ to adjust the horizontal position.</p> <p>V: As the setting for V (vertical) increases, the picture moves up, and as the setting decreases, the picture moves down. Use ▲/▼ to adjust the vertical position.</p>
----------------------	---

Setup Menu

The Setup menu is used to change the factory preset settings, etc.

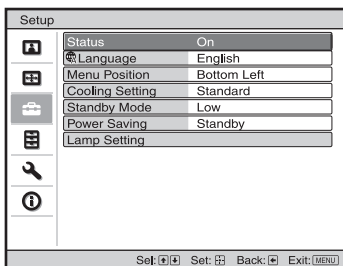

Status	<p>Sets whether or not the on-screen display is displayed. Set to “Off” to turn off the on-screen displays except for certain menus, message when turning off the power, and warning messages.</p>
Language	<p>Selects the language used in the menu and on-screen displays. Available languages are: English, Dutch, French, Italian, German, Spanish, Portuguese, Russian, Swedish, Norwegian, Japanese, Chinese (Simplified Chinese), Chinese (Traditional Chinese), Korean, Thai, and Arabic.</p>
Menu Position	<p>You can change the position to display the menu on the screen. Bottom Left: Displays the menu on the bottom left area of the screen. Center: Displays the menu on the center of the screen.</p>
Cooling Setting	<p>Sets the unit to operate at the prevailing atmospheric pressure. High: Use this setting when using the unit at an altitude of 1,500 m or higher. Standard: Use this setting when using the unit at normal altitudes. Tip When this item is set to “High,” the fan noise becomes slightly louder since the number of fan rotations increases.</p>
Standby Mode	<p>You can select the power consumption in standby. Standard: The power consumption in standby mode is normalized. Low: The power consumption in standby mode is lowered. Tip When this item is set to “Low,” the “PJ Auto Power On” function is disabled (The function is set to “Off” and does not appear in the menu). The network function is also disabled in standby mode.</p>

Power Saving	Sets the power saving mode. Lamp Cutoff: If no signal is input for 10 minutes, the lamp turns off automatically and power consumption is reduced. If signal is resumed, or any button on the control panel or remote control is pressed, the lamp will light again. In Lamp Cutoff, the ON/STANDBY indicator lights in orange. (☞ page 8) Standby: If no signal is input for 10 minutes, power is turned off automatically and the projector goes into standby mode. Off: The power saving mode is released.
Lamp Setting	When replacing the lamps, set the desired lamp setting (☞ page 75).

Function Menu

The Function menu is used for changing the settings of the various functions of the unit.

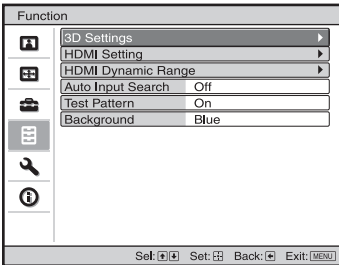

3D Settings

You can change the settings of the 3D function.

2D-3D Display Sel.: For Switching the video images to “2D” or “3D.”

Auto: Displays 3D video images when HDMI signals with 3D information are input. Displays 2D video images when other signals are input.

3D: Displays 3D video images according to the 3D system selected in “3D Format.” However, when HDMI signals with 3D information are input to the unit, displays 3D video images according to the 3D system of those HDMI signals.

2D: Displays 2D video images.

* The 3D information is additional information to discriminate 3D. Some HDMI signals have additional information to discriminate 3D and some HDMI signals have none.

3D Format: Set the 3D system when the input HDMI signals do not include 3D information.

Simulated 3D: Converts 2D video images to 3D video images. The setting can be made only for input the HD signals.

- The simulated 3D feature may have limited effect, depending on the video source.
- There are differences in perception of 3D video images among individuals.

Side-by-Side: Select this to display 3D images as two similar images, side-by-side.

Over-Under: Select this to display 3D images as two similar images, one above the other.

3D Settings	<p>3D Brightness: For adjusting the brightness of the picture when watching 3D video images. You can select the brightness “High” or “Standard.”</p> <p>3D Depth Adjust: For adjusting the depth of the 3D video images on the screen. The setting can be made only when a 3D Format other than “Simulated 3D” is selected.</p> <p style="text-align: center;"> Depth -2 -1 0 +1 +2 Front ← Normal → Depth </p> <p>We recommend that “3D Depth Adjust” be set to “0.” The 3D video images may be difficult to perceive, depending on the setting of “3D Depth Adjust.”</p> <p>Simulated 3D Effect: For adjusting the 3D effect when 2D content is converted to 3D video images. You can select the effect from among “High,” “Middle,” and “Low.”</p> <p>Tips</p> <ul style="list-style-type: none"> • “2D-3D Display Sel.” cannot be set to “3D” for some video sources. For available 3D signals, see “Compatible 3D Signals” (☞ page 84). • The simulated 3D feature may have limited effect, depending on the screen size (100 to 120 inches recommended) and the video source. • There are differences in perception of 3D video images converted by the simulated 3D function among individuals. • The menu display has a ghost while a 3D video image is displayed and is best viewed with the 3D glasses.
HDMI Setting	<p>You can change the settings of the Control for HDMI function.</p> <p>Control for HDMI: Selects the function whether to turn the Control for HDMI function effective when the HDMI 1 and HDMI 2 connectors are connected to a Control for HDMI compatible equipment.</p> <p>When set to “On,” the following are available.</p> <ul style="list-style-type: none"> • The operation of the unit and the connected Control for HDMI compatible equipment will synchronize with each other. • The Control for HDMI setting of Sony equipment (AV amplifier, video, etc.), which is compatible with “Control for HDMI - Easy Setting,”* will also be effective. <p>Device Auto Power Off: Sets whether to also turn the power of the connected Control for HDMI compatible equipment off when you turn the power of the unit off.</p> <p>When set to “On,” the equipment will synchronize and turn off when the power of the unit turns off.</p> <p>PJ Auto Power On: Select whether to link the power of the unit to the Control for HDMI compatible equipment.</p> <p>When set to “On,” the power of the unit will automatically turn on when the power of the connected equipment is turned on or when making operations such as playback.</p> <p>Tip</p> <p>To enable this function, set “Standby Mode” (☞ page 50) on the Setup  menu to “Standard,” and then set “PJ Auto Power On” to “On.” For details, see “About the Control for HDMI” (☞ page 65).</p>

HDMI Setting	<p>Device List: Lists all the Control for HDMI compatible equipment connected to the unit.</p> <p>When “Enable” is selected, the Control for HDMI setting of Sony equipment (AV amplifier, video, etc.), which is compatible with “Control for HDMI - Easy Setting,”* will also be effective.</p> <div data-bbox="486 229 902 608" style="border: 1px solid black; padding: 5px; margin: 10px auto; width: fit-content;"> <table border="1" style="width: 100%; border-collapse: collapse;"> <thead> <tr> <th colspan="3" style="text-align: left; padding: 2px;">Device List</th> </tr> <tr> <th style="text-align: left; padding: 2px;">Input</th> <th style="text-align: left; padding: 2px;">Device</th> <th style="text-align: left; padding: 2px;">Type</th> </tr> </thead> <tbody> <tr> <td style="padding: 2px;">HDMI 1</td> <td style="padding: 2px;">Player 1</td> <td style="padding: 2px;">BD</td> </tr> <tr> <td style="padding: 2px;">HDMI 2</td> <td style="padding: 2px;">Player 2</td> <td style="padding: 2px;">DVD</td> </tr> </tbody> </table> <p style="font-size: small; margin-top: 10px;">Would you like to enable for HDMI settings for connected devices? Before enabling settings, turn on the devices. For unrecognized devices, check settings on their side.</p> <p style="text-align: center; margin-top: 5px;"><input type="button" value="Enable"/></p> <p style="text-align: right; font-size: x-small; margin-top: 5px;">Set: [] Back: [MENU]</p> </div> <p>* “Control for HDMI - Easy Setting” is a function that makes the Control for HDMI setting of equipment connected to HDMI input of the unit effective as well when the Control for HDMI setting of the unit is effective. Non-Sony equipment is not compatible.</p>	Device List			Input	Device	Type	HDMI 1	Player 1	BD	HDMI 2	Player 2	DVD
Device List													
Input	Device	Type											
HDMI 1	Player 1	BD											
HDMI 2	Player 2	DVD											
HDMI Dynamic Range	<p>Set the video input level for inputting RGB-format signals to the HDMI 1 and HDMI 2 connectors.</p> <p>Auto: Sets the video input level automatically.</p> <p>Limited: The video input level is set for signals of 16-235.</p> <p>Full: The video input level is set for signals of 0-255.</p> <p>Note</p> <p>If the video output setting of the connected HDMI device is not set correctly, light and dark parts of the video may appear too light or too dark.</p>												
Auto Input Search	<p>Enables selection from only the input which has a signal.</p> <p>When set to “On,” inputs without signals do not appear on the input palette that appears when you press INPUT. To display all inputs, set this to “Off” (Ⓞ page 27).</p>												
Test Pattern	<p>Displays a test pattern according to the setting.</p> <p>On: A test pattern appears on the screen to be used when adjusting the lens with “Lens Focus,” “Lens Zoom,” and “Lens Shift.”</p> <p>Off: A test pattern does not appear.</p> <p>Tip</p> <p>While the test pattern is displayed, it is only displayed in green to allow you to adjust the focus easily.</p>												
Background	<p>Selects the background color of the screen when no signal is input.</p> <p>You can select “Black” or “Blue.”</p>												

Installation Menu

The Installation menu is used for changing the installation settings.

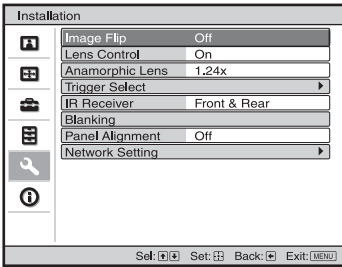

<p>Image Flip</p>	<p>Flips the picture on the screen horizontally and/or vertically. HV: Flips the picture horizontally and vertically. H: Flips the picture horizontally. V: Flips the picture vertically. Off: The picture does not flip. Use this item for installation for the backside projection or ceiling installation.</p>
<p>Lens Control</p>	<p>Avoids any operation of the lens such as “Lens Focus,” “Lens Zoom,” and “Lens Shift,” by mistake. On: Enables adjustment of the lens. Off: Prevents any adjustment of the lens.</p>
<p>Anamorphic Lens</p>	<p>Select a setting to match the anamorphic lens conversion ratio. 1.24x: Select this when you use an anamorphic lens with a horizontal rate of 1.24x. 1.32x: Select this when you use an anamorphic lens with a horizontal rate of 1.32x.</p>
<p>Trigger Select</p>	<p>Switches the output function of the TRIGGER 1/TRIGGER 2 connector. Off: Turns off the TRIGGER connector function. Power: Outputs 12 V signals from the TRIGGER 1/TRIGGER 2 connectors when the unit is on. The TRIGGER 1/TRIGGER 2 connectors do not output any signals when the unit is in standby. V Stretch: Works with the “Aspect” setting’s “V Stretch” (☞ page 48) and outputs a 12 V signal from the TRIGGER 1 or TRIGGER 2 connector. 2.35:1 Zoom: Works with the “Aspect” setting’s “2.35:1 Zoom” (☞ page 48) and outputs a 12 V signal from the TRIGGER 1 or TRIGGER 2 connector.</p>
<p>IR Receiver</p>	<p>Selects the remote control detectors (IR Receiver) on the front and rear of the unit. Front & Rear: Activates both the front and rear detectors. Front: Activates the front detector only. Rear: Activates the rear detector only.</p>

Blanking

This feature allows you to adjust the displayable region within the four directions of the screen.

Select the edge to adjust by highlighting Left, Right, Top, or Bottom using the **↑/↓** buttons.

Adjust the amount of blanking using the **←/→** buttons.

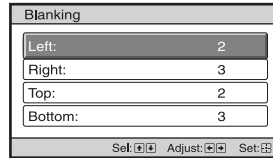

The screenshot shows a dialog box titled "Blanking" with four input fields: "Left:" with value 2, "Right:" with value 3, "Top:" with value 2, and "Bottom:" with value 3. At the bottom of the dialog are three buttons: "Set: [F1]", "Adjust: [F2]", and "Set: [F3]".

Direction	Value
Left:	2
Right:	3
Top:	2
Bottom:	3

Tip

Depending on the aspect ratio setting, right/left blanking may not be available.

Panel Alignment

This feature allows you to adjust the gaps in the color of characters or the picture.
 When set to “On,” “Adjust Color” and “Pattern Color” can be assigned and adjusted.
Adjust Item: Selects how to make adjustments from below.
Shift: Shifts the whole picture and makes adjustments.
Zone: Selects the desired range and makes adjustments.
Adjust Color: Assigns the desired color to adjust the gaps in color. Select “R” (Red) or “B” (Blue) to make adjustments based on “G” (Green).
Pattern Color: Select “R/G” (Red and Green) or “R/G/B” (White, all colors) when “Adjust Color” is “R” (Red). Select “B/G” (Blue and Green) or “R/G/B” (White, all colors) when the “Adjust Color” is “B” (Blue).
Adjust: The shift adjustment and zone adjustment of the color selected in “Adjust Color” can be made with ←/→, ↑/↓ buttons.
When “Shift” is selected: Assign the settings of the horizontal direction (H) with ←/→ buttons and the vertical direction (V) with ↑/↓ buttons on the shift adjustment screen.

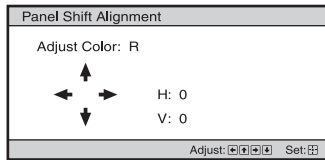

When “Zone” is selected: Select the position to adjust with ←/→ buttons for the horizontal position (H position) and ↑/↓ buttons for the vertical position (V position), then press Ⓢ.

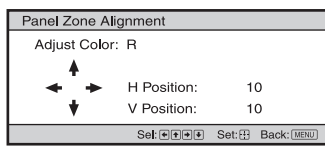

Set the amount to adjust with ←/→ buttons for the horizontal direction (H direction) and with ↑/↓ buttons for the vertical direction (V direction). You can select the position to adjust again by pressing Ⓢ.

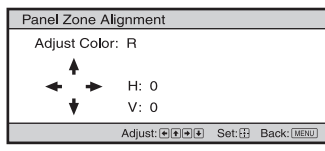

Reset: Returns to the factory settings.

Note

Depending on the adjustments made above, colors may become uneven or the resolution may change.

<p>Network Setting</p>	<p>Perform internet protocol settings. Set this when accessing from a computer (☞ page 60) or using the supplied gamma control adjustment software “ImageDirector3.” IP Address Setup: Select the IP address setting method. Auto (DHCP): The IP address is assigned automatically from the DHCP server such as a router. Manual: Specify the IP address manually.</p> <p>When “Manual” is selected for “IP Address Setup,” select the item with the ◀/▶ buttons and input the value with the ▲/▼ buttons. When all items are entered, select “Apply,” and then press the ⊕ button. The entered settings will be registered.</p> <p>IP Address: Set the unit’s IP address. (1.0.0.0 – 223.255.255.255) Subnet Mask: Set the unit’s subnet mask. (1.0.0.0 – 255.255.255.255) Default Gateway: Set the unit’s default gateway. (1.0.0.0 – 223.255.255.255) Primary DNS: Set the primary DNS server. (1.0.0.0 – 223.255.255.255) Secondary DNS: Set the secondary DNS server. (1.0.0.0 – 223.255.255.255) MAC Address: Display the unit’s MAC address. This cannot be changed.</p>
-------------------------------	--

Information Menu

The Information menu displays the model name, serial number, the horizontal and vertical frequencies of the input signal and the cumulated hours of usage of the lamp.

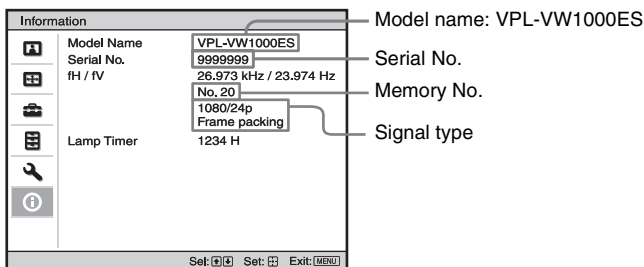



Model name	Displays the model name (VPL-VW1000ES).
Serial No.	Displays the serial number.
fH (horizontal frequency)	Displays the horizontal frequency of the input signal.
fV (vertical frequency)	Displays the vertical frequency of the input signal.
Memory No.	Displays the preset memory number of the input signal.
Signal type	Displays the type of the input signal. When input signals with 3D information are input, the type of input signals and the 3D format are displayed.
Lamp Timer	Indicates how long the lamp has been turned on (total usage).

Notes

- fH (horizontal frequency) and fV (vertical frequency) may not be displayed depending on the input signal used on the unit.
- You cannot adjust or change the displays listed above.

About the Preset Memory No.

This unit has 35 types of preset data for input signals (the preset memory). When the preset signal is input, the unit automatically detects the signal type and recalls the data for the signal from the preset memory to adjust it to an optimum picture. The memory number and signal type of that signal are displayed in the Information  menu.

You can also adjust the preset data through the Screen  menu.

This unit also contains 20 different user memories beside the preset memories used for analog computer signals. You can save input signals that have not been preset on these user memories. When an unpreset signal is input for the first time, a memory number is displayed as 0. When you update the signal settings with “Adjust Signal” of the Screen  menu, it will be registered to the unit. If more than 20 user memories are registered, the newest memory always overwrites the oldest one.

See the chart on page 79 to find if the signal is registered to the preset memory.

Note

Depending on the computer input signal, parts of screen may be hidden or displayed incorrectly.

Using Network Features

Connection to the network allows you to operate the following features:

- Checking the current status of the unit via a Web browser.
- Remotely controlling the unit via a Web browser.
- Receiving the e-mail report for the unit.
- Making the network settings for the unit.
- Supports network monitoring and control protocol (Advertisement, PJ Talk, AMX DDDP [Dynamic Device Discovery Protocol]).
- Using the supplied gamma control software “ImageDirector3.”

Notes

- The menu displays used for the explanation below may be different depending on the model you are using.
- Supported Web browsers are Internet Explorer 6/7/8.
- The menu displays only English.
- If the browser of your computer is set to [Use a proxy server] when you have access to the unit from your computer, click the check mark to set accessing without using a proxy server.

Displaying the Control Window of the Unit with a Web Browser

1 Connect the LAN cable.

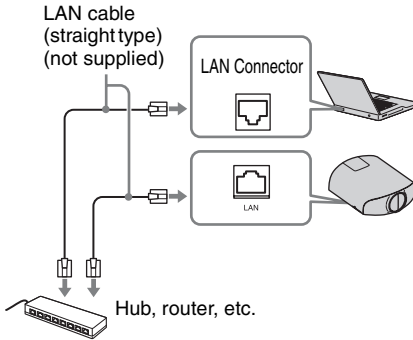

CAUTION

For safety, do not connect the connector for peripheral device wiring that might have excessive voltage to this port. Follow the instructions for this port.

ATTENTION

Par mesure de sécurité, ne raccordez pas le connecteur pour le câblage de périphériques pouvant avoir une tension excessive à ce port. Suivez les instructions pour ce port.

VORSICHT

Aus Sicherheitsgründen nicht mit einem Peripheriegerät-Anschluss verbinden, der zu starke Spannung für diese Buchse haben könnte. Folgen Sie den Anweisungen für diese Buchse.

2 Set the network settings for the unit using “Network Setting” on the Installation menu (page 58).

3 Start a web browser on the computer, enter the following in the address field, then press the Enter key on your computer.

`http://xxx.xxx.xxx.xxx`

(xxx.xxx.xxx.xxx: IP address for the unit)

You can confirm the IP address of the unit under “Network Setting” on the Installation  menu.

The following window appears in the Web browser:

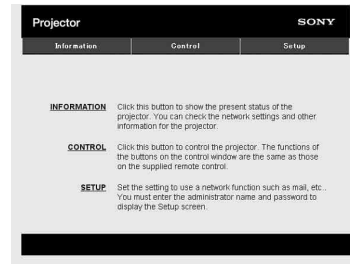

Once you make the network settings, you can open the Control window only by performing step **3** of this procedure.

Operating the Control Window

Switching the Page

Click one of the Page Switching buttons to display the desired setting page.



Page Switching buttons

Setting the Access Limitation

You can limit a user for accessing any particular page.

Administrator: Allowed access to all pages

User: Allowed access to all pages except the Setup page

Set under [Password] of the Setup page. When you access the Setup page for the first time, enter “root” for user name and enter nothing for password.

The name of the administrator is preset to “root.”

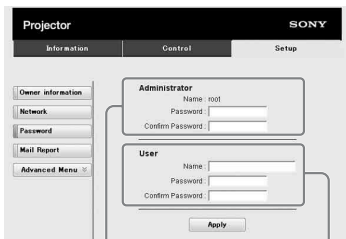

Entry area for [Administrator]

Entry area for [User]

When you change the password, input a new password after deleting the password (****) that was set.

Note

If you forget your password, consult with qualified Sony personnel.

Confirming the Information Regarding the Unit

You can confirm the current settings for the unit on the Information page.



Information area

Operating the Unit from a Computer

You can control the unit from the computer on the Control page.

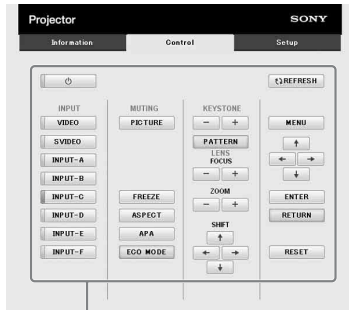

Operation area

The functions of the buttons shown in the operation area are the same as those of the buttons on the supplied remote control.

Using the E-mail Report Function

Set the e-mail report function on the Setup page.

Entered values will not be applied unless you click on [Apply].

- 1 Click on [Owner information] to enter the owner information recorded in the e-mail report.

The screenshot shows the 'Projector' setup menu with three tabs: 'Information', 'Control', and 'Setup'. The 'Information' tab is active. On the left, there is a vertical menu with options: 'Owner information', 'Network', 'Password', 'Mail Report', and 'Advanced Menu'. The 'Owner information' option is highlighted with a box and a line pointing to the number '1' below it. The main area shows the 'Owner' information form with fields for Name, Organization, Projector Location, and Installation, along with a Memo field and an Apply button.

Owner information button

1

- 2 Set the timing of the e-mail report.

Click on [Mail Report] to open the Mail Report page.

Lamp Reminder (Lamp1): Set the timing for lamp replacement. To reset Lamp Reminder, execute "Lamp Setting" on the unit (page 51).

Maintenance Reminder: Set the timing for maintenance. To reset Maintenance Reminder, check the RESET check box and then click on [Apply].

Mail Report button

The screenshot shows the 'Mail Report' page. It has three tabs: 'Information', 'Control', and 'Setup'. The 'Setup' tab is active. On the left, there is a vertical menu with options: 'Owner information', 'Network', 'Password', 'Mail Report', and 'Advanced Menu'. The 'Mail Report' option is highlighted with a box and a line pointing to the number '2' above it. The main area is divided into sections: 'Report Timing' (with fields for Lamp Reminder, Maintenance Reminder, and Elapsed Hours, and a RESET button), 'Address' (with fields for TO and CC, and checkboxes for Report Timing, Maintenance, and Error), and 'Mail Account' (with fields for Mail Address, Outgoing Mail Server, Account Name, and Password, and radio buttons for Required Authentication and SMTP Authentication). At the bottom, there is a checkbox for 'Send test mail' and a 'View' button for 'Check the contents of the mail message', with an Apply button at the very bottom. Numbered callouts 3, 4, 5, and 6 point to the Address, Mail Account, Send test mail, and Check the contents of the mail message sections respectively.

- 3 Enter the outgoing e-mail address in the Email Address box, then check the Report Timing check box of the e-mail report to be sent.

- 4 Set the mail account for sending e-mail reports.

Mail Address: Enter the e-mail address.
Outgoing Mail Server (SMTP): Enter the address of outgoing mail server (SMTP).

Required Authentication: Check this check box if authentication is required for sending e-mail.

Requires the use of POP

Authentication before send email

(POP before SMTP): Check this check box to arrange for POP authentication to be performed before sending e-mail.

Incoming Mail Server (POP3): Enter the address of the incoming-mail server (POP3) to be used for POP authentication.

Account Name: Enter the mail account.

Password: Enter the password.

SMTP Authentication: Check this check box to arrange for SMTP authentication to be performed before sending e-mail.

Account Name: Enter the mail account.

Password: Enter the password.

5 Confirm the contents of the e-mail report.

When you click on [View], the contents of the e-mail report are displayed.

6 Send the test mail.

Check on the Send test mail check box, then click on [Apply] to send your test mail to the e-mail address you set.

Notes

- You cannot use the e-mail report function because Outbound Port 25 Blocking on the network is preventing a connection to the SMTP server.
- You cannot enter the following characters in the text box: ', ", \, &, <, >

This section describes about the other functions, how to solve the problems, how to replace the lamp, etc.

About the Control for HDMI

What is the Control for HDMI?

Control for HDMI is an HDMI standard mutual control function which uses the HDMI CEC (Consumer Electronics Control) specification. By connecting a variety of Control for HDMI compatible equipment such as a hard disk Blu-ray Disc player, a DVD player/recorder, an AV amplifier, etc. to a Sony Control for HDMI compatible TV or a projector with an HDMI cable, the equipment connected will synchronize with the TV or the projector when either is operated.

Using the Control for HDMI function

- Connect and assign the settings of each equipment appropriately.
- Do not turn off the main power of the equipment.
- Set the input setting of the projector to the HDMI input which the equipment is connected.
- Check if the picture from the equipment appears appropriately on the projector.

Connecting a Control for HDMI compatible equipment

Use an HDMI cable to connect the projector and the Control for HDMI compatible equipment. Use a cable that has acquired the HDMI logo.

Setting the Control for HDMI

Be sure to assign the appropriate settings for both the projector and the Control for HDMI compatible equipment connected to the projector. For settings of the projector, see

page 53. For settings of the Control for HDMI compatible equipment connected to the projector, refer to its operating instructions. When equipment that is compatible with the “Control for HDMI - Easy Setting” is connected to the HDMI input of the projector, if you turn the Control for HDMI function setting of the projector on, the Control for HDMI function setting of the connected equipment will also turn on.

What you can do with the Control for HDMI

- By turning on or playing back the connected equipment, the projector will turn on and the input setting will switch to the terminal of the connected equipment automatically.
- By turning the power of the projector off, the power of the connected equipment will also turn off automatically.
- By changing the language setting of the projector, the language setting of the connected equipment will also change to the same language automatically.

Notes

- The available functions of the Control for HDMI differ depending on each equipment. Refer to the operating instruction of each equipment.
- Some synchronization may be available with equipment of other brands with similar functions, but it is not guaranteed.

About DCI specification

DCI is a specification for Digital cinema projection systems, established by the industry standards body DCI (Digital Cinema Initiatives), an affiliation of six major Hollywood studios.

About the x.v.Color

- “x.v.Color” is a promotion name given to the products that have the capability to realize a wide color space based on the xvYCC specifications and is a trademark of Sony Corporation.
- xvYCC is an international standard of the technical specifications of the extended-gamut color space for video signals. The color gamut of xvYCC is wider than the one of sRGB that is used with the current television system.

About the simulated 3D feature

- Use the simulated 3D function taking into account that the picture will provide a different look from the original images, because this function converts the video images.
- Note that if the unit is used for profit or for public viewing, displaying 2D video images as 3D video images by converting to the simulated 3D may constitute an infringement of the rights of authors or producers, which are legally protected.



Troubleshooting

If the unit appears to be operating erratically, try to diagnose and correct the problem using the following instructions. If the problem persists, consult with qualified Sony personnel.

Power



Symptom	Cause and Remedy
The power is not turned on.	<ul style="list-style-type: none"> → The power may not turn on if you turn the power off with I/⏻ (ON/STANDBY) button and turn it on again in a short time. After about 1 minute, turn the power on. → Close the lamp cover securely, then tighten the screws securely (☞ page 74). → Check warning indicators (☞ page 70).
The power is suddenly turned off.	<ul style="list-style-type: none"> → Check that “Power Saving” in the Setup  menu is set to “Standby.” (☞ page 51) → Set “Power Saving” to “Off.”

Picture

Symptom	Cause and Remedy
No picture.	<ul style="list-style-type: none"> → Check that the connecting cable is connected to the external equipment properly (☞ page 22). → Select the input source correctly using the INPUT button (☞ page 27). → Check that the computer signal is set for output to an external monitor. → If the notebook computer, etc., signal is output to its display and an external monitor, the external monitor’s image may not be displayed correctly. Set your computer to output the signal to only an external monitor.
The picture has ghosts.	→ Video images are displayed in 3D. Watch the 3D video images using the 3D glasses, and set “2D-3D Display Sel.” to “3D” (☞ page 52).
Bright or dark area of the video appears too bright or too dark.	→ This symptom may occur when RGB signal level other than those of HDMI standard is input. Switch the RGB output level of the connected equipment, or switch the HDMI Dynamic Range of the unit (☞ page 54).
The picture is too dark.	→ Adjust “Contrast” or “Brightness” on the Picture  menu properly (☞ page 42).
The picture is not clear.	<ul style="list-style-type: none"> → Adjust the focus (☞ page 18). → Condensation has accumulated on the lens. Leave the unit for about 2 hours with the power on.
The picture flickers.	→ For pictures from an analog computer, adjust “Phase” for “Adjust Signal” on the Screen  menu properly (☞ page 49).

Symptom	Cause and Remedy
The color of characters or the picture is not appropriate.	→ Select the desired color registration in “Panel Alignment” of the Installation  menu (☞ page 57).
Image is left on the screen. (image retention)	→ When high contrast non-moving images are displayed for a long period of time, there may be some image retention on the screen. This is only a temporary condition. Turning off the power for a while will eliminate the retained image.

On-screen display

Symptom	Cause and Remedy
On-screen display does not appear.	<ul style="list-style-type: none"> → Set “Status” on the Setup  menu to “On” (☞ page 50). → Check if the ON/STANDBY indicator should light in green. When the ON/STANDBY indicator blinks in green, the unit is starting up. Wait until it stops blinking and remains lit in green.
The model name does not disappear from the screen.	→ The display mode of the unit may be set at the time of purchase. Consult with your local dealer or qualified Sony personnel.
Input terminals do not appear.	→ Set “Auto Input Search” on the Function  menu to “Off” (☞ page 54).

Remote control

Symptom	Cause and Remedy
The remote control does not work.	<ul style="list-style-type: none"> → Batteries could be weak. Replace them with new batteries (☞ page 11). → Insert the batteries with the correct polarities (☞ page 11). → If there is a fluorescent lamp near the remote control detector, the unit may work improperly or inadvertently. → If you use the optional 3D Sync Transmitter and point it to the remote control detector of the unit, the remote control may not work properly. → Confirm the position of the remote control detector on the unit (☞ page 8). → Set “IR Receiver” to “Front & Rear” on the Installation  menu (☞ page 55).

3D video images

Symptom	Cause and Remedy
The video image does not seem like 3D video images.	<ul style="list-style-type: none"> → Check if the 3D glasses are turned on (☞ page 29). → Make sure that the battery in the 3D glasses is charged. → Check if the input source is HDMI. → Set “2D-3D Display Sel.” to “Auto” or “3D” (☞ page 52). → Check if the input signals are compatible 3D signals (☞ page 84). → If no 3D signal is input from the 3D equipment connected to the unit, restarting the connected 3D equipment may solve the problem. → When the viewing or projector position is too far from the screen, the 3D glasses may not be able to display the images properly (☞ page 30). → If you use the optional 3D Sync Transmitter, check that it is placed within the specified range (☞ page 25). → The screen size is not appropriate. Set the zooming magnification to low or watch the image from farther away from the screen (☞ page 90).

Others

Symptom	Cause and Remedy
The fan is noisy.	<ul style="list-style-type: none"> → Check the setting of “Cooling Setting” on the Setup  menu (☞ page 50). → Make sure that the room temperature is not too high. → Check the installation conditions (☞ page 13). The number of fan rotation increases to maintain the product reliability of the projector’s components in a room, where the temperature is higher than normal. The fan noise becomes slightly louder. The approximate normal temperature is 25°C.
The lens shift cannot be adjusted.	<ul style="list-style-type: none"> → The lens shift cannot be adjusted over the range of movement. Adjust the lens shift within the range of movement (☞ pages 21, 89).
The unit and connected equipment turn On/Off, play back, and operate at the same time.	<ul style="list-style-type: none"> → “Control for HDMI,” “Device Auto Power Off,” and “PJ Auto Power ON” are set to “On.” Set them to “Off.” For details, see “HDMI Setting” (☞ page 53).

Warning Indicators

The ON/STANDBY or LAMP/COVER indicator lights up or flashes if there is any trouble with your projector.

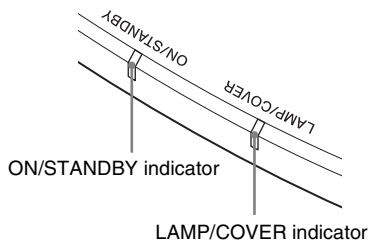

Symptom	Cause and Remedy
LAMP/COVER flashes in red. (A repetition rate of 2 flashes)	→ Close the lamp cover securely, then tighten the screws securely (☞ page 74).
LAMP/COVER flashes in red. (A repetition rate of 3 flashes)	<ul style="list-style-type: none"> → The temperature of lamp is unusually high. Turn off the power and wait for the lamp to cool, then turn on the power again. → If the symptom persists, the lamp may be at the end of its service life. In this case, replace the lamp with a new one (☞ page 73).
ON/STANDBY flashes in red. (A repetition rate of 4 flashes)	→ The fan is broken. Consult with qualified Sony personnel.
ON/STANDBY flashes in red. (A repetition rate of 2 flashes)	→ The internal temperature is unusually high. Check to ensure that if nothing is blocking the ventilation holes or whether or not the unit is being used at high altitudes.
ON/STANDBY flashes in red. (A repetition rate of 6 flashes)	→ Press the I/⏻ (ON/STANDBY) button to turn on the unit. If the power is not turned on, disconnect the AC power cord, then confirm the ON/STANDBY lamp is turned off. After about 10 seconds, reconnect the AC power cord and turn on the power again. If the indicators still light up, the electrical system has a problem. Consult with qualified Sony personnel.

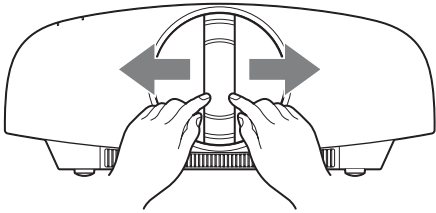
Symptom	Cause and Remedy
ON/STANDBY flashes in red. (A repetition rate of 5 flashes)	<p>→ The lens protector is not fully open. Turn the power of the unit off and then on again. If the lens protector still does not fully open, consult with qualified Sony personnel.</p> <p>Tip In an urgent situation, refer to the illustration below to open the lens protector with your hands. Press the I/⏻ (ON/STANDBY) button to turn the power on and operate the unit.</p> 

Note

When a warning indicator other than the above starts flashing, and the symptom persists even after carrying out the above methods, consult with qualified Sony personnel.

Message Lists

Warning messages

Message	Cause and Remedy
High temp.! Lamp off in 1 min.	<p>→ Turn off the power.</p> <p>→ Check to ensure that nothing is blocking the ventilation holes (☞ page 14).</p>
Frequency is out of range!	<p>→ Frequency is out of range. Input a signal that is within the acceptable frequency range of the unit (☞ page 79).</p>
Please replace the Lamp.	<p>→ It is time to replace the lamp. Replace the lamp (☞ page 73).</p> <p>→ If this message appears again after you replace the lamp, the lamp replacement process is not complete. Check the lamp replacement process (☞ page 73).</p> <p>Note To clear this message, press any button either on the remote control or the control panel of the unit once.</p>
Projector temperature is high. Cooling Setting should be “High” if projector is being used at high altitude.	<p>→ Check to ensure that the ventilation holes on the unit are not covered (☞ page 14).</p> <p>→ When using the unit at high altitude, set “Cooling Setting” to “High” (☞ page 50).</p> <p>Note When temperature inside the unit remains high, “Cooling Setting” is switched to “High” in 1 minute, then the fan speed increases.</p>

Message	Cause and Remedy
Power Saving Mode is set. Projector lamp will automatically cutoff in 1 minute.	<p>→ “Power Saving” is set to “Lamp Cutoff.” (☞ page 51)</p> <p>Note</p> <p>If no signal is input, the lamp turns off after 1 minute.</p>
Power Saving Mode is set. Projector will automatically enter Standby Mode in 1 minute.	<p>→ “Power Saving” is set to “Standby.” (☞ page 51)</p> <p>Note</p> <p>If no signal is input, the power turns off after 1 minute, and the projector goes into standby mode.</p>

Caution messages

Message	Cause and Remedy
⌘→	<p>→ No signal is input in the selected input. Check connections (☞ page 22).</p>
Not applicable!	<p>→ Press the appropriate button.</p> <p>→ The operation to be activated by the button is currently prohibited.</p>

Replacing the Lamp and Cleaning the Ventilation Holes (intake)

The lamp used for the light source has a certain lifespan. When the lamp dims, the color balance of the picture becomes strange, or “Please replace the Lamp.” appears on the screen, the lamp may be exhausted. Replace the lamp with a new one (not supplied) without delay.

Tools you need to get started:

- Projector Lamp LMP-H330 (Optional)
- Standard Phillips screwdriver
- Cloth (for scratch protection)

Caution

- The lamp remains hot after the unit is turned off with the I/⏻ (ON/STANDBY) button. If you touch the lamp, you may burn your fingers. When you replace the lamp, wait for at least 1 hour for the lamp to cool.
- Do not touch the surface of the lens. If you touch it, wipe off the fingerprints with a soft cloth.
- Pay special attention to replacing the lamp when the unit is installed on the ceiling.
- When replacing the lamp of a unit which is on the ceiling, do not stand directly under the lamp cover. When removing the lamp door (inner cover), avoid twisting it. If the lamp explodes, fragments may cause injury.
- When removing the lamp unit, make sure it remains horizontal, then pull straight up. Do not tilt the lamp unit. If you pull out the lamp unit while tilted and if the lamp breaks, the pieces may scatter, causing injury.

- 1 Turn off the unit and unplug the AC power cord.
- 2 When setting the unit on a flat surface such as a desk etc., put a cloth to prevent the surface from being scratched. Place the unit on the cloth.

Note

Be sure that the unit is placed on a stable surface.

- 3 While pressing the  part indicated in the lamp cover illustration, slide ① and then open ② the lamp cover.

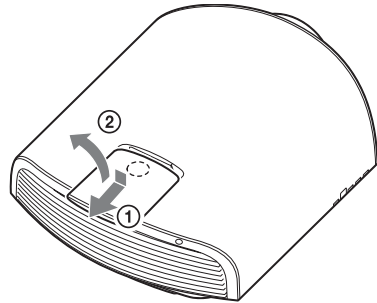

- 4 Loosen the lamp door (inner cover) screw with a Phillips screwdriver, and then open the lamp door.

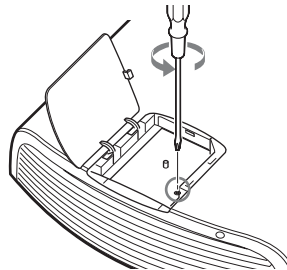

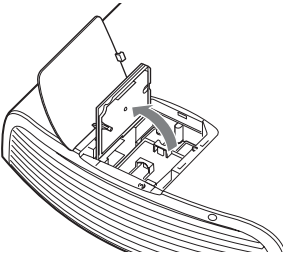

- 5** Loosen the 3 screws on the lamp with the Phillips screwdriver. Hold up the handle, then pull the lamp straight out.

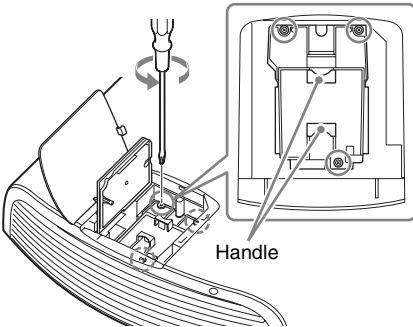

Note

Hold the lamp by the handle to remove and attach it.

- 6** Push in the new lamp by the handle securely until it reaches the end, and then tighten the 3 screws.

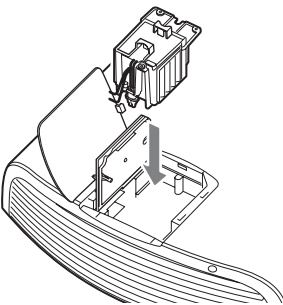

Note

Be careful not to touch the optical block inside the unit.

- 7** Close the lamp door, (inner cover) and then tighten the screw.

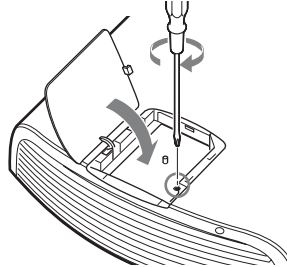

- 8** Close the lamp cover.

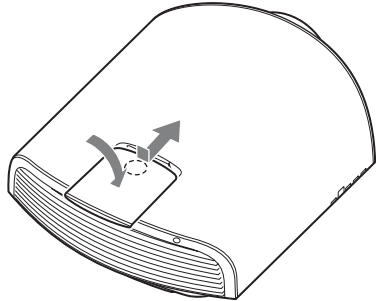

- 9** Wipe dust off the ventilation holes (intake) with a soft cloth.

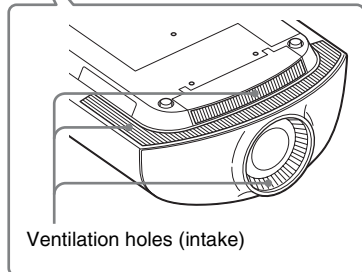
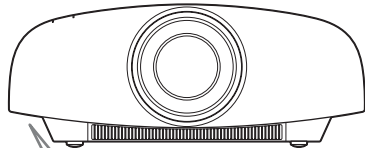

Ventilation holes (intake)

10 Turn on the unit, then select the desired setting item on the Setup menu.

The menu screen below will be appeared.

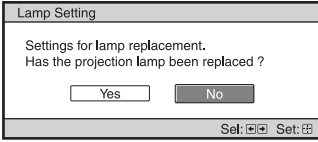

11 Select "Yes."

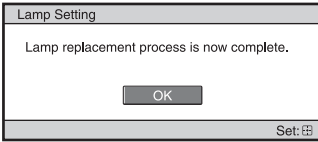

Caution

Do not put your hands into the lamp replacement slot, and do not allow any liquid or other objects into the slot to avoid electrical shock or fire.

Notes

- Be sure to use an LMP-H330 Projector Lamp for replacement. If you use lamps other than the LMP-H330, the unit may malfunction.
- Be sure to turn off the unit and unplug the power cord before replacing the lamp, then check the ON/STANDBY indicator has already been turned off.
- The unit will not turn on unless the lamp is securely installed in place.
- The unit will not turn on unless the lamp cover are securely closed.
- To cancel a message displayed on the screen, press either the button on the remote control or the one on the control panel on the unit.

Note on replacing the lamp when broken, in the case of a ceiling installation

If the lamp breaks, broken lamp pieces may scatter and cause injury.

When the unit is on the ceiling, remove the lamp door (inner cover) by sliding it horizontally slowly after raising it with 30 degree opened. Avoid twisting the lamp door (inner cover).

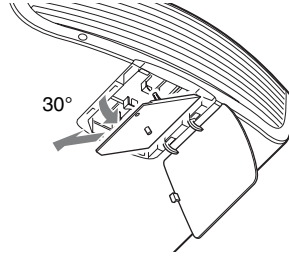

Note

The lamp contains mercury. The disposal rules for used fluorescent tubes depend on where you live. Follow the waste disposal policy in your area.

Disposal of the used lamp

For the customers in the USA

Lamp in this product contains mercury. Disposal of these materials may be regulated due to environmental considerations. For disposal or recycling information, please contact your local authorities or the Telecommunications Industry Association (www.eiae.org).

Mettre à disposition de la lampe usagée

Pour les clients aux États-Unis

La lampe dans ce produit contient du mercure. La disposition de ces matériaux peut être réglementée suite à des considérations environnementales. Pour obtenir des informations de disposition ou de recyclage, veuillez communiquer avec vos autorités locales ou la Telecommunications Industry Association (www.eiae.org).

Cleaning and the Screen of the Projector

Cleaning the cabinet

- To remove dust from the cabinet, wipe gently with a soft cloth. If dust is persistent, wipe with a soft cloth slightly moistened with a diluted mild detergent solution.
- Never use any type of abrasive pad, alkaline/acid cleaner, scouring powder, or volatile solvent, such as alcohol, benzene, thinner or insecticide.
- Clean the unit with a cleaning cloth. Wiping with a dirty cloth may scratch the unit.
- Using such materials or maintaining prolonged contact with rubber or vinyl materials may result in damage to the screen surface and cabinet material.

Black points and bright points (red, blue, or green) on the screen

The projector is manufactured using high-precision technology.

You may, however, see tiny black points and/or bright points (red, blue, or green) that continuously appear on the projector.

This is a normal result of the manufacturing process and does not indicate a malfunction.

Specifications

System

Display system	SXRD panel, projection system
Display device	Size of effective display area 0.74-inch (18.8 mm) SXRD Number of pixels 26,542,080 pixels (8,847,360 pixels × 3)
Projection lens	2.1 times zoom lens (motorized) f=21.3 mm to 46.2 mm F2.9 to F3.9
Light source	Ultra High Pressure Lamp 330 W type
Screen size	60 inches to 300 inches (1,524 mm to 7,620 mm) (measured diagonally)
Accepted digital and analog video signals:	480/60i, 576/50i, 480/60p, 576/50p, 720/60p, 720/50p, 1080/60i, 1080/50i The following items are available for digital signal (HDMI input) only: 1080/60p, 1080/50p, 1080/24p, 3840 × 2160/24p, 3840 × 2160/25p, 3840 × 2160/30p, 4096 × 2160/24p
Accepted computer signals:	fH: 19 kHz to 72 kHz fV: 48 Hz to 92 Hz Maximum resolution 1,920 × 1,080 (HDMI input only) For details, see “Preset Signals” (☞ page 79).

Input/Output

HDMI (2 inputs)	Digital RGB/Y Pb/Cb Pr/Cr
Y Pb/Cb Pr/Cr	Component: phono type Y with Sync: 1 Vp-p±2 dB sync negative (75 ohms terminated) Pb/Cb: 0.7 Vp-p±2 dB (75 ohms terminated) Pr/Cr: 0.7 Vp-p±2 dB (75 ohms terminated)
INPUT A	Mini D-sub 15-pin Analog RGB: R: 0.7 Vp-p±2 dB (75 ohms terminated)

G: 0.7 Vp-p±2 dB (75 ohms terminated)
G with sync/Y: 1 Vp-p±2 dB sync negative (75 ohms terminated)
B: 0.7 Vp-p±2 dB (75 ohms terminated)
SYNC/HD: Composite sync input: TTL level, positive/ negative
Horizontal sync input: TTL level, positive/negative
VD: Vertical sync input: TTL level, positive/negative

TRIGGER (2 connectors)	Minijack DC 12 V Max. 100 mA
REMOTE	RS-232C: D-sub 9-pin (female)
LAN	RJ45, 10BASE-T/100BASE-TX
IR IN	Minijack
3D SYNC	RJ45 connector

General

Outside dimensions (w/h/d)	520 mm × 200 mm × 640 mm (20 1/2 × 7 7/8 × 25 1/4 inches) (without protrusions)
Mass	Approx. 20 kg (44 lb 1.5 oz)
Power requirements	AC 100 V to 240 V, 4.8 A to 2.0 A, 50/60 Hz
Power consumption	480 W
Standby power requirements	3.9 W (when “Standby Mode” is set to “Standard”) 0.4 W (when “Standby Mode” is set to “Low”)
Operating temperature	5°C to 35°C (41°F to 95°F)
Operating humidity	35% to 85% (no condensation)
Storage temperature	-20°C to +60°C (-4°F to +140°F)
Storage humidity	10% to 90%

Supplied accessories

Remote control RM-PJ22 (1)
Size AA (R6) manganese batteries (2)
AC power cord for projector (1)
Plug holder (1)
AC inlet cover (1)
3D glasses (2)
Pouch for the 3D glasses (2)

USB charging AC power adaptor (AC-UD10) (1)
 Specifications
 Input voltage: AC 100 to 240 V,
 0.2 A, 50/60 Hz
 Rated output voltage: DC 5 V,
 1.5 A

Note

Please use the above power requirements.

AC power cord for USB charging AC power adaptor (1)

For the customers in the U.S.A. and Canada
WARNING:

Using this unit at a voltage other than 120 V may require the use of a different line cord or attachment plug, or both. To reduce the risk of fire or electric shock, refer servicing to qualified service personnel.

USB charging cable (G2551-0077-00/-01 or APY5244-010020/SONY) (1.2 m) (1)

Câble de charge USB (G2551-0077-00/-01 ou APY5244-010020/SONY) (1,2 m) (1)

CD-ROM (ImageDirector3) (1)

Operating Instructions (1)

Warning on power connection

Use a proper power cord for your local power supply.

	The United States, Canada	Continental Europe	UK, Ireland, Australia, New Zealand	Japan	China
Plug type	YP-3	YP-12A	*	YP-359	VM0722
Female end	YC-13	YC-13D	VM0303B	YC-13	VM0724
Cord type	SVT	H05VV-F	CEE (13) 53 rd (OC)	VCTF	227 IEC 53(RVV)
Rated Voltage & Current	10A/125V	10A/250V	10A/250V	12A/125V	10A/250V
Safety approval	UL/CSA	VDE	VDE	DENANHO	CCC

* Use a rated plug that complies with the regulation of each country/region and the specifications.

Optional accessories

Projector Lamp

LMP-H330 (for replacement)

Projector Suspension Support

PSS-H10

3D glasses

TDG-PJ1

3D Sync Transmitter

TMR-PJ1, TMR-PJ2

Notes

- Not all optional accessories are available in all countries and area. Please check with your local Sony Authorized Dealer.
- Information on accessories in this manual is current as of December 2011.

Design and specifications of this unit and its optional accessories are subject to change without notice.

Note

The values for mass and dimensions are approximate.

Preset Signals

The following table shows the signals and video formats which you can project using this unit.

When a signal other than the preset signal shown below is input, the picture may not be displayed properly.

Preset memory no.	Preset signal (resolution)		fH (kHz)	fV (Hz)	Sync	H Size
3	480/60i	480/60i (720 × 480i)	15.734	59.940	SonG/Y	–
4	576/50i	576/50i (720 × 576i)	15.625	50.000	SonG/Y	–
5	480/60p	480/60p (Progressive NTSC) (720 × 480p)	31.470	60.000	SonG/Y	–
6	576/50p	576/50p (Progressive PAL) (720 × 576p)	31.250	50.000	SonG/Y	–
7	1080/60i	1035/60i (1920 × 1035i) 1080/60i (1920 × 1080i)	33.750	60.000	SonG/Y	–
8	1080/50i	1080/50i (1920 × 1080i)	28.130	50.000	SonG/Y	–
10	720/60p	720/60p (1280 × 720p)	45.000	60.000	SonG/Y	–
11	720/50p	720/50p (1280 × 720p)	37.500	50.000	SonG/Y	–
12	1080/60p	1080/60p (1920 × 1080p)	67.500	60.000	–	–
13	1080/50p	1080/50p (1920 × 1080p)	56.260	50.000	–	–
14	1080/24p	1080/24p (1920 × 1080p)	26.973	23.976	–	–
18	720/60p (Frame packing)	720/60p (1280 × 720p)	90.000	60.000	–	–
19	720/50p (Frame packing)	720/50p (1280 × 720p)	75.000	50.000	–	–
20	1080/24p (Frame packing)	1080/24p (1920 × 1080p)	53.946	23.976	–	–

Preset memory no.	Preset signal (resolution)		fH (kHz)	fV (Hz)	Sync	H Size
26	640 × 480	VESA 60	31.469	59.940	H-neg, V-neg	800
28		VESA 72	37.861	72.809	H-neg, V-neg	832
29		VESA 75 (IBM M3)	37.500	75.000	H-neg, V-neg	840
30		VESA 85 (IBM M4)	43.269	85.008	H-neg, V-neg	832
31	800 × 600	VESA 56	35.156	56.250	H-pos, V-pos	1024
32		VESA 60	37.879	60.317	H-pos, V-pos	1056
33		VESA 72	48.077	72.188	H-pos, V-pos	1040
34		VESA 75 (IBM M5)	46.875	75.000	H-pos, V-pos	1056
35		VESA 85	53.674	85.061	H-pos, V-pos	1048
37	1024 × 768	VESA 60	48.363	60.004	H-neg, V-neg	1344
38		VESA 70	56.476	70.069	H-neg, V-neg	1328
39		VESA 75	60.023	75.029	H-pos, V-pos	1312
45	1280 × 960	VESA 60	60.000	60.000	H-pos, V-pos	1800
47	1280 × 1024	VESA 60	63.974	60.013	H-pos, V-pos	1696
50	1400 × 1050	SXGA +	65.317	59.978	H-neg, V-pos	1864
55	1280 × 768	1280 × 768/60	47.776	59.870	H-neg, V-pos	1664
56	1280 × 720	1280 × 720/60	44.772	59.855	H-neg, V-pos	1664
93	3840 × 2160/24p	3840 × 2160/24p (3840 × 2160)	53.946	23.976	–	–
94	3840 × 2160/25p	3840 × 2160/25p (3840 × 2160)	56.25	25	–	–
95	3840 × 2160/30p	3840 × 2160/30p (3840 × 2160)	67.4325	29.97	–	–
96	4096 × 2160/24p	4096 × 2160/24p (4096 × 2160)	54	24	–	–

Preset memory numbers for each input signal

Analog signal

Signal	Preset memory number
Component signal (Y Pb/Cb Pr/Cr connectors)	3 to 8, 10, 11
Computer signal (INPUT A connector)	26, 28 to 35, 37 to 39, 55, 56

Digital signal

Signal	Preset memory number
Component signal (HDMI 1, 2 connectors)	3 to 8, 10 to 14, 18 to 20, 93 to 96
Video GBR signal (HDMI 1, 2 connectors)	3 to 8, 10 to 14, 18 to 20, 93 to 96
Computer signal (HDMI 1, 2 connectors)	10 to 13*, 26, 32, 37, 45, 47, 50, 55

* Some digital signals input from computers may be displayed as preset memory number of Component or Video GBR signal.

Input Signals and Adjustable/Setting Items

The items in the menus available to adjust differ depending on the input signal. The following tables indicate them.

The items that cannot be adjusted are not displayed in the menu.

Picture menu

Item	Input signal		
	Component signal	Video GBR signal	Computer signal
Reality Creation	●	●	–
Advanced Iris	●	●	●
Lamp Control	●	●	●
Film Projection	●	●	–
Motion Enhancer	● (excluding preset memory numbers 93 to 96)	● (excluding preset memory numbers 93 to 96)	–
Contrast	●	●	●
Brightness	●	●	●
Color	●	●	–
Hue	●	●	–
Color Temp.	●	●	●
Sharpness	●	●	–
NR	● (excluding preset memory numbers 93 to 96)	● (excluding preset memory numbers 93 to 96)	–
MPEG NR	● (excluding preset memory numbers 93 to 96)	● (excluding preset memory numbers 93 to 96)	–
Smooth Gradation	● (excluding preset memory numbers 93 to 96)	● (excluding preset memory numbers 93 to 96)	–
Film Mode	● (excluding preset memory numbers 14, 20, and 93 to 96)	● (excluding preset memory numbers 14, 20, and 93 to 96)	–
Black Level Adj.	● (excluding preset memory numbers 93 to 96)	● (excluding preset memory numbers 93 to 96)	–
Gamma Correction	●	●	●

Item	Input signal		
	Component signal	Video GBR signal	Computer signal
Color Correction	●	●	●
Clear White	●	●	●
x.v.Color	●	–	–
Color Space	●	●	●

- : Adjustable/can be set
 – : Not adjustable/cannot be set

Screen menu

Item	Input signal		
	Component signal	Video GBR signal	Computer signal
Aspect* ¹	● (excluding preset memory number 96)	● (excluding preset memory number 96)	–
Over Scan	● (excluding preset memory numbers 93 to 96)	● (excluding preset memory numbers 93 to 96)	–
Phase	–	–	● * ²
Pitch	–	–	● * ²
Shift	● * ²	● * ²	●

- : Adjustable/can be set
 – : Not adjustable/cannot be set
 *¹: For further details, refer to the tables in “Aspect Mode.” (☞ page 85)
 *²: The setting can be made only for analog signal.

Note

When connecting a cable such as an HDMI cable, etc., check the type of the signal in the Information  menu (☞ page 59) and Digital signal (☞ page 81), and check items that are adjustable/can be set.

Compatible 3D Signals

This unit accepts the following types of 3D signals.

Resolution	3D signal format
720/60, 50P	Side-by-Side format
	Over-Under format*
	Frame packing*
1080/60, 50i	Side-by-Side format*
1080/24P	Over-Under format*
	Frame packing*
1080/60, 50P	Side-by-Side format
	Over-Under format

*: Mandatory 3D format of the HDMI standards.

3D Signals and Adjustable/Setting Items

Some items on the menus may not be available to adjust/set, depending on the 3D signals. The items that cannot be adjusted are not displayed on the menu. The following tables indicate those items.

Item	3D signals			
	720/60, 50P	1080/60, 50i	1080/24P	1080/60, 50P
Reality Creation	●	●	●	●
Advanced Iris	-	-	-	-
Lamp Control	●	●	●	●
Film Projection	-	-	-	-
Motion Enhancer	-	-	●	-
NR	-	-	-	-
MPEG NR	-	-	-	-
Smooth Gradation	-	-	-	-
Film Mode	-	-	-	-
x.v.Color	●	●	●	●
Aspect	●	● (Squeeze cannot be selected)	●	●
Over Scan	-	-	-	-

●: Adjustable/can be set

-: Not Adjustable/cannot be set

When the unit is set to convert 2D video images to 3D video images, some items on the menus may be not available to adjust/set, depending on the “3D Format” settings on the Function  menu. The items that cannot be adjusted are not displayed on the menu. The following tables indicate these items.

Item	3D format		
	Over-Under	Side-by-Side	Simulated 3D
Reality Creation	●	●	●
Advanced Iris	–	–	–
Lamp Control	●	●	●
Film Projection	–	–	–
Motion Enhancer	● (preset memory number 14 only)	–	●
NR	–	–	●
MPEG NR	–	–	●
Smooth Gradation	–	–	●
Film Mode	–	–	–
x.v.Color	●	●	●
Aspect* ¹	●	●	●
Over Scan	–	–	–

*¹: For further details, refer to the tables in “Aspect Mode.” ( page 85)

Aspect Mode

Selectable items vary depending on the type of input signal or 3D format.
For details, see the tables below. Items that cannot be selected are not displayed in the menu.

2D

Acceptable signals	4096 × 2160	3840 × 2160	1920 × 1080 1280 × 720	720 × 480 720 × 576	Others
Preset memory number (☞ page 79)	96	93 to 95	7, 8, 10 to 14	3 to 6	26, 28 to 35, 37 to 39, 55, 56
1.85:1 Zoom	–	–	●	●	–
2.35:1 Zoom	–	●	●	●	–
Normal	● * ¹	●	●	●	● * ¹
Stretch	–	–	–	●	–
V Stretch	–	–	●	●	–
Squeeze	–	–	●	●	–

*¹: Not displayed in the menu as fixed at Normal.

3D

Acceptable signals	1920 × 1080, 1280 × 720			
	Side-by-Side	Over-Under	Frame packing	Simulated 3D
Preset memory number (☞ page 79)	7, 8, 10 to 13	10 to 14	18 to 20	18 to 20
1.85:1 Zoom	●	●	●	●
2.35:1 Zoom	●	●	●	●
Normal	●	●	●	●
Stretch	–	–	–	–
V Stretch	●	●	●	●
Squeeze	● * ²	●	●	●

*²: Squeeze cannot be selected if preset memory number 7, 8 or 13 (☞ page 79) is input.

Storage Conditions of Adjustable/Setting Items

Each adjustable/setting item is individually stored for each input connector or preset signal. For further details, see the tables below.

Preset memory numbers for each input signal

Input	Preset memory numbers
Input-A	26, 28 to 35, 37 to 39, 55, 56
Component	3 to 8, 10, 11
HDMI 1 (2D)	3 to 8, 10 to 14, 18 to 20, 26, 32, 37, 45, 47, 50, 55, 93 to 96
HDMI 2 (2D)	

Input	Preset memory numbers
HDMI 1 (3D)	7, 8, 10 to 14, 18 to 20
HDMI 2 (3D)	

Picture menu

Item	Storage conditions
Calib. Preset	For each input connector and preset signal
Reset	For each input connector and Calib. Preset
Reality Creation	
Advanced Iris	
Lamp Control	
Film Projection	
Motion Enhancer	
Contrast	
Brightness	
Color	
Hue	
Color Temp.	
D93-D55	
Custom 1-5	
Gain R	For each Color Temp., Custom 1-5
Gain G	
Gain B	
Bias R	
Bias G	
Bias B	
Sharpness	For each input connector and Calib. Preset
NR	
MPEG NR	
Smooth Gradation	
Film Mode	
Black Level Adj.	
Gamma Correction	
Color Correction	
Clear White	
x.v.Color	
Color Space	

Screen menu

Item	Storage condition
Aspect	For Picture Position 1.85:1, 2.35:1, or Custom 1-3
Over Scan	For each input connector and preset signal
Adjust Signal: Phase (Analog PC signal)	For each input connector and preset signal
Adjust Signal: Pitch (Analog PC signal)	For each input connector and preset signal
Adjust Signal: Shift (All analog signals)	For each input connector and preset signal

Projection Distance and Lens Shift Range

The projection distance refers to the distance between the front of the lens and the projected surface.

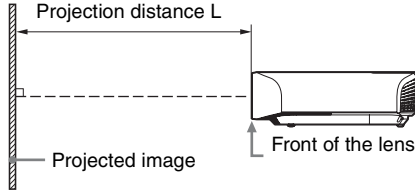

The lens shift range represents the distance in percent (%) by which the lens can be shifted from the center of the projected image. The lens shift range is regarded as 0% when the point **A** in the illustration (point where a line drawn from the center of the lens and the projected image cross at right angles) is aligned with the center of the projected image and full width or full height of the projected image is regarded as 100%.

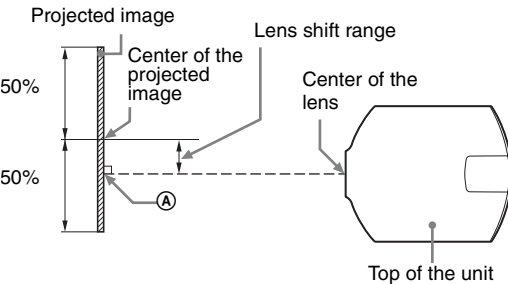
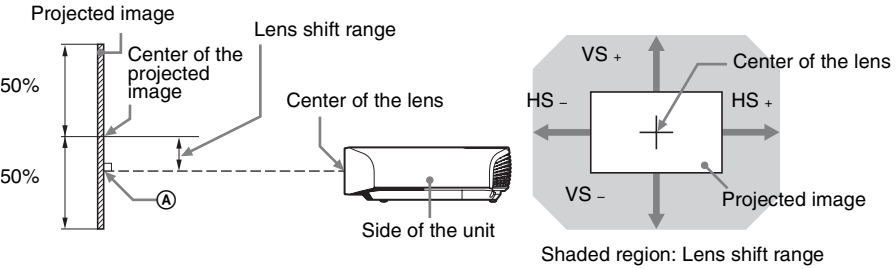

- VS +: Vertical lens shift range (up) [%]
- VS -: Vertical lens shift range (down) [%]
- HS +: Horizontal lens shift range (right) [%]
- HS -: Horizontal lens shift range (left) [%]

When projecting in 1.90:1 (Native Full Display 17:9) format

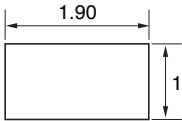

Projection distance

Unit: m (inches)

Projection image size		Projection distance L
Diagonal	Width × Height	
80" (2.03 m)	1.80 × 0.95 (71 × 37)	2.23 – 4.90 (88 – 192)
100" (2.54 m)	2.25 × 1.18 (88 × 47)	2.81 – 6.14 (111 – 241)
120" (3.05 m)	2.70 × 1.42 (106 × 56)	3.39 – 7.38 (134 – 290)
150" (3.81 m)	3.37 × 1.78 (133 × 70)	4.25 – 9.25 (168 – 364)
200" (5.08 m)	4.49 × 2.37 (177 × 93)	5.70 – 12.36 (225 – 486)

Projection distance formula

D: Projected image size (Diagonal)

Unit: m (inches)

Projection distance L (minimal length)	Projection distance L (maximal length)
$L = 0.028860 \times D - 0.0800$ $(L = 1.136218 \times D - 3.1491)$	$L = 0.062212 \times D - 0.0756$ $(L = 2.449310 \times D - 2.9775)$

Lens shift range

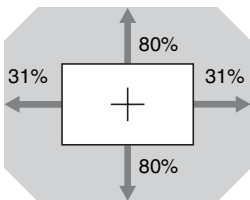

$$VS + = VS - = 80 - 2.581 \times (HS + \text{ or } HS -) [\%]$$

$$HS + = HS - = 31 - 0.388 \times (VS + \text{ or } VS -) [\%]$$

When projecting in 1.78:1 (16:9) format

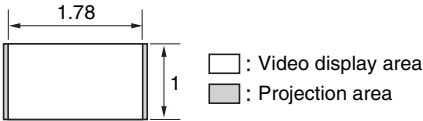

Projection distance

Unit: m (inches)

Projection image size		Projection distance L
Diagonal	Width × Height	
80" (2.03 m)	1.77 × 1.00 (70 × 39)	2.35 – 5.15 (93 – 202)
100" (2.54 m)	2.21 × 1.25 (87 × 49)	2.96 – 6.46 (117 – 254)
120" (3.05 m)	2.66 × 1.49 (105 × 59)	3.56 – 7.77 (141 – 305)
150" (3.81 m)	3.32 × 1.87 (131 × 74)	4.47 – 9.73 (176 – 383)
200" (5.08 m)	4.43 × 2.49 (174 × 98)	5.99 – 13.00 (236 – 511)

Others

Projection distance formula

D: Projected image size (Diagonal)

Unit: m (inches)

Projection distance L (minimal length)	Projection distance L (maximal length)
$L = 0.030333 \times D - 0.0800$ $(L = 1.194198 \times D - 3.1491)$	$L = 0.065387 \times D - 0.0756$ $(L = 2.574296 \times D - 2.9775)$

Lens shift range

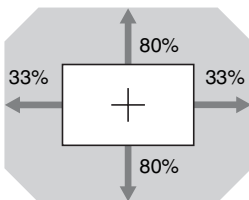

$$VS + = VS - = 80 - 2.424 \times (HS + \text{ or } HS -) [\%]$$

$$HS + = HS - = 33 - 0.413 \times (VS + \text{ or } VS -) [\%]$$

When projecting in 2.35:1 format

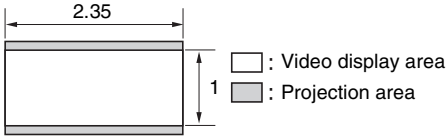

Projection distance

Unit: m (inches)

Projection image size		Projection distance L
Diagonal	Width × Height	
80" (2.03 m)	1.87 × 0.80 (74 × 31)	2.33 – 5.10 (92 – 200)
100" (2.54 m)	2.34 × 0.99 (92 × 39)	2.93 – 6.39 (116 – 251)
120" (3.05 m)	2.80 × 1.19 (110 × 47)	3.53 – 7.69 (139 – 302)
150" (3.81 m)	3.51 × 1.49 (138 × 59)	4.43 – 9.63 (175 – 379)
200" (5.08 m)	4.67 × 1.99 (184 × 78)	5.93 – 12.86 (234 – 506)

Projection distance formula

D: Projected image size (Diagonal)

Unit: m (inches)

Projection distance L (minimal length)	Projection distance L (maximal length)
$L = 0.030024 \times D - 0.0800$ $(L = 1.182064 \times D - 3.1491)$	$L = 0.064723 \times D - 0.0756$ $(L = 2.548138 \times D - 2.9775)$

Lens shift range

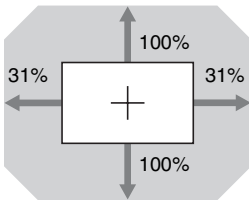

$$VS + = VS - = 100 - 3.226 \times (HS + \text{ or } HS -) [\%]$$

$$HS + = HS - = 31 - 0.310 \times (VS + \text{ or } VS -) [\%]$$

The distance between the front of the lens and the front of the cabinet

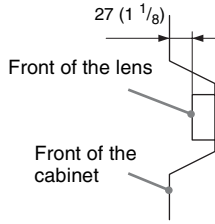

Attaching the PSS-H10 projector suspension support

Caution

Do not mount the projector on the ceiling or move it by yourself. Be sure to consult with qualified Sony personnel (charged).

To dealers

Use the Sony PSS-H10 Projector Suspension Support, and take measures to prevent falling using wire, etc.

For details, refer to the installation manual for dealers of the PSS-H10.

Front view

Unit: mm (inches)

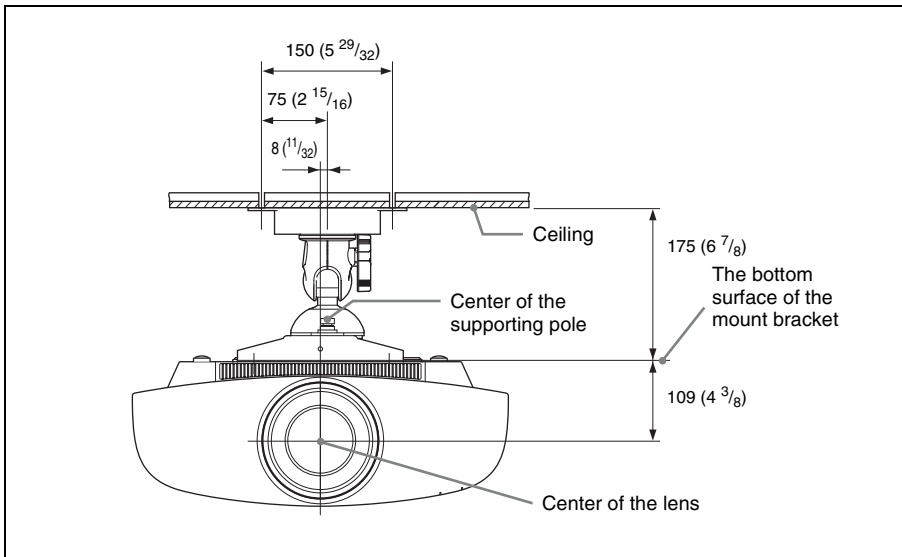

Side view

Unit: mm (inches)

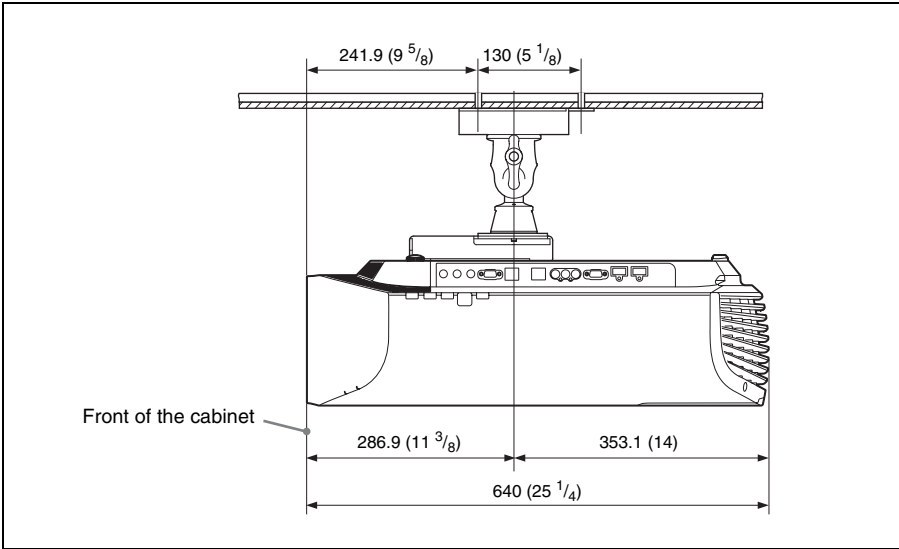

Others

Top view

Unit: mm (inches)

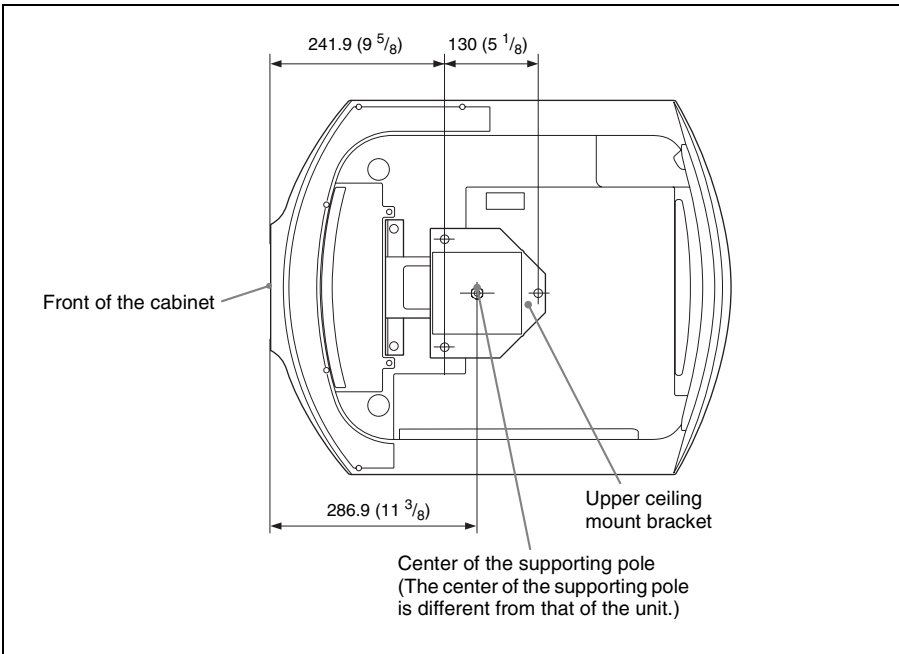

Index

Numerics

3D Glasses	
3D glasses communication range	30
Using the 3D Glasses	29
3D Settings	
2D-3D Display Sel.	52
3D Brightness	53
3D Depth Adjust	53
3D Format	52
Simulated 3D Effect	53

A

Acceptable 3D Signals	84
Adjust Signal	
Phase	49
Pitch	49
Shift	49
Adjusting	
picture position	17
Advanced Iris	42
Anamorphic Lens	55
Aspect	48
1.85:1 Zoom	34, 48
2.35:1 Zoom	34, 48
Normal	35, 48
Squeeze	36, 48
Stretch	35, 48
V Stretch	35, 48
Aspect Ratio	34
Auto Input Search	54

B

Background	54
Black Level Adj. (Adjust)	44
Blanking	56
Brightness	43

C

Calib. Preset	
Bright Cinema	41
Bright TV	41
Cinema Digital	41
Cinema Film 1	41
Cinema Film 2	41
Game	41
Photo	41
Reference	41

TV	41
Cinema Black Pro	42
Clear White	45
Color	43
Color Correction	45
Color Space	46
Color Temp.	43
Connecting	
3D Sync Transmitter	25
Computer	24
Video equipment	22
Contrast	42
Cooling Setting	50

D

DCI specification	66
Dimensions	93

E

Expert Setting	44
----------------	----

F

fH	59
Film Mode	44
Film Projection	42
Front feet (adjustable)	21
fV	59

G

Gamma Correction	45
------------------	----

H

HDMI	22
HDMI Dynamic Range	54
HDMI Setting	53
Hue	43

I

Image Flip	55
ImageDirector3	38, 45
IR Receiver	55

L

Lamp Control	42
Lamp Setting	51
Lamp Timer	59
LAN connector	8, 61
Language	50
Lens Control	55

Location of Controls	
Front/Right side	8
Rear/Bottom	9

M

Menu	
Function	52
Information	59
Installation	55
Picture	41
Screen	47
Setup	50
Messages	
Caution	72
Warning	71
Motion Enhancer	42
Motionflow	42
MPEG NR	44

N

Network	60
Network Setting	58
NR	44

O

Over Scan	48
-----------------	----

P

Panel Alignment	57
Picture Position	
Picture Position	47
Using the Picture Position	32
Power Saving	51
Precautions	7
Preset Memory	59
Preset mode	
BRT CINE	37
BRT TV	37
CINEMA DIGITAL	37
CINEMA FILM 1	37
CINEMA FILM 2	37
GAME	37
PHOTO	37
REF	37
TV	37
Preset Signals	79
Projection distance	90, 91, 92

R

Reality Creation	42
------------------------	----

Remote control	
inserting the batteries	11
location of controls	10
Reset	
resettable items	40
resetting the items	40

S

Selecting the menu language	26
Sharpness	43
Smooth Gradation	44
Specifications	77
Standby Mode	50
Status	50
Supplied accessories	11

T

Test Pattern	54
Trigger Select	55
Troubleshooting	67

X

x.v.Color	45, 66
-----------------	--------

